

OS 3050 OS 3051

Controller for reverse osmosis plants



Instruction manual

Softwareversion 3.04

Contents

Overview	1
"PRODUCTION" mode	1
"STANDBY" mode	2
"RINSE" Mode	2
"MAINTENANCE" Mode	3
"STANDBY STOP" step	3
Dosage of chemicals	3
Measurement of Conductivity	3
Temperature measurement and compensation	4
Illustration MODEL OS 3050 / MODEL OS 3051	5
Measurements and function display	6
LED display	6
LED control indicators	6
LCD display	7
Top line of LCD display	7
Bottom line of LCD display	7
Bottom line of LCD display in "PRODUCTION" mode	7
Bottom line of LCD display in "RINSE" mode	7
Bottom line of LCD display in "STANDBY" mode	8
Bottom line of LCD display in "MAINTENANCE" mode	8
INFO - display	9
Input states - 1	9
Input states - 2	9
Output states	9
Service - telephone number / To change the telephone number	10
Software version	10
Alarm relays A-H	10
Alarm relays I-P	11
Malfunction relays A-H	11
Malfunction relays I-P	11
Rinse interval	12
Concentrate rinse	12
Cell constant	12
Maintenance interval	12
Temperature display	12
Manual Operation	13
"PRODUCTION" mode	13
"STANDBY" mode	13
"MAINTENANCE" mode	14
Terminate "RINSE"	14
Start "Interval Rinse"	14
Reset ALARM/MALFUNCTION	14
ALARMS/MALFUNCTIONS	15
CM 1 MIN	15
CM 1 MAX	15
CM 2 MIN	15
CM 2 MAX	15
CM % MIN	16
CM % MAX	16
Stop	16
Stop by hand	16
Tank Full	16

Tank Empty	17
Overpressure	17
Low pressure 1	17
Low pressure 2	17
Low pressure 3	18
Concentrate 1	18
Concentrate 2	18
Concentrate 3	18
Motor safeguard switch.....	19
Temperature MAX	19
Power Failure	19
Standby stop.....	19
Output functions	20
High pressure pump/three-phase regulator	20
Inlet valve	20
Concentrate discharge valve	20
Permeate discharge valve	20
Dosing Pump	21
Alarm Relay	21
Malfunction Relay	21
Recorder Output	21
Input functions	22
STOP	22
Tank full/empty	22
High pressure	22
Low pressure	23
Concentrate low flow	23
Alarm reset	23
Motor safeguard switch.....	23
Conductivity sensor 1 and 2	23
Temperature sensor	23
Display and Modification of Setpoints	24
1. Conductivity Meter 1.....	25
2. Conductivity Meter 2.....	27
3. Display of Relative Conductivity Meter 1	29
4. Temperature measurement and temperature compensation.....	31
5. Conductivity - Correction Factor	32
6. Start Up Delay	32
7. Concentrate Flow Monitoring / Alarm reset	33
8. Rinse before Standby	34
9. "Interval" Rinse	34
10. Dosing Pump	35
11. Level Control	36
12. Low Pressure	36
13. Alarm Relay	37
14. Malfunction Relay.....	39
15. Recorder Output.....	41
16. Maintenance.....	43
17. Permeate valve	44
18. Stop Hand start	44
Central Monitoring	45
Installation instructions / start-up instructions. / "Standby stop" when put into operation	46
Time diagram	47
Connection terminals	48
Technical specifications	49
Declaration of conformity	50



Overview

The OS3050 (external) console and OS3051 (internal) panel-mounted controllers are used for automatic monitoring and control of water treatment units, based on the principle of reversed osmosis.

The following description applies to a standard unit. Depending on the size of the unit, the quality of the water which is to be treated, the usage for the desalinated water and local regulations, the actual unit supplied may be different than that described here. Alternative designs include such types as multi-stage units, permeate or concentrate return units. Furthermore, the permeate discharge valve is not always included as standard. Refer to the installation notes and operation instructions specific to your equipment.

The pre-programmed values and setpoints in the controller can be altered at any time; their storage is non-volatile, i.e., the modified values are retained even in the event of a power failure.

The controller can be in four modes, "PRODUCTION", "STANDBY", "RINSE" and "MAINTENANCE."

"PRODUCTION" mode

The start of the PRODUCTION is depending on the programming of step 11.1 and the state of the level switches (input FU en EM). It is possible to stop the PRODUCTION by hand with the OFF key. There will be no production until the ON key is pressed.

When "PRODUCTION" mode commences, the inlet valve opens. After an adjustable delay of 1-999 seconds, the h.p. pump starts operation.

Alternative it is possible to program a second variant with rinsing by the concentrate discharge valve: the concentrate discharge valve opens - delay - the inlet valve opens - delay - the h.p. pump starts - delay - the concentrate discharge valve closes. This delay is adjustable between 1 - 999 seconds. The water then travels via the inlet valve and h.p. pump to the reverse osmosis membrane.

From here, a stream of water with an increased salt content (concentrate) passes via the concentrate control valve into the sewer. A stream of desalinated water (permeate) of the desired purity flows into a storage tank. Desalinated water which does not meet the requirements flows via the permeate discharge valve into the sewer.

During the "PRODUCTION" phase, the following values can be monitored (if the controller is programmed for them, the optional I/O boards are installed and the required sensors are connected to the inputs):

Conductivity 1 under lower limit	Low pressure input
Conductivity 1 exceeds upper limit	Overpressure input
Conductivity 2 under lower limit	Concentrate flow input
Conductivity 2 exceeds upper limit	Stop Production input
Relative conductivity 2 below lower limit	Tank full input
Relative conductivity 2 exceeds upper limit	Tank empty input
Water temperature exceeds upper limit	Motor protection input

A built-in timer registers the production stage to the minute for up to 65'000 hours.



"STANDBY" mode

In "STANDBY" mode, water flow is stopped. The inlet valve and the concentrate discharge valve are closed. Only the permeate discharge valve is open. The pump is turned off.

The following values can be monitored (if the controller is programmed to do so and the appropriate sensors are connected to the inputs):

Tank empty input
Tank full input

Motor protection input
Water temperature exceeds upper limit

"RINSE" mode

There is made a discrimination between "Rinse before Standby-Mode" and "Interval Rinse". In the steps 8.3 and 9.4 will respectively programmed, whether the rinse will be done with the high pressure pump and whether the inlet valve and the concentrate valve will be opened.

A possibly connected permeate valve is always open.

Rinse before Standby mode

"Rinse" mode can be started after completion of "Production" mode, in order to flush concentrate from the membrane. Besides the "Rinse" mode will be started after turning on the power. In step 8.2 it is possible to set a rinse time of 1-9999 seconds.

Example: the inlet valve, the concentrate discharge valve and the permeate discharge valve open. The high pressure valve can be optionally activated after an adjustable delay of 1-999 seconds. Water flows via the inlet valve and the high pressure pump to the membrane. The main stream flows via the concentrate discharge valve and the adjustable concentrate valve into the sewer. A small amount of water flows via the permeate discharge valve into

the sewer. If a U-bend is included in the permeate piping (see the drawing below), no water can flow into the storage tank.

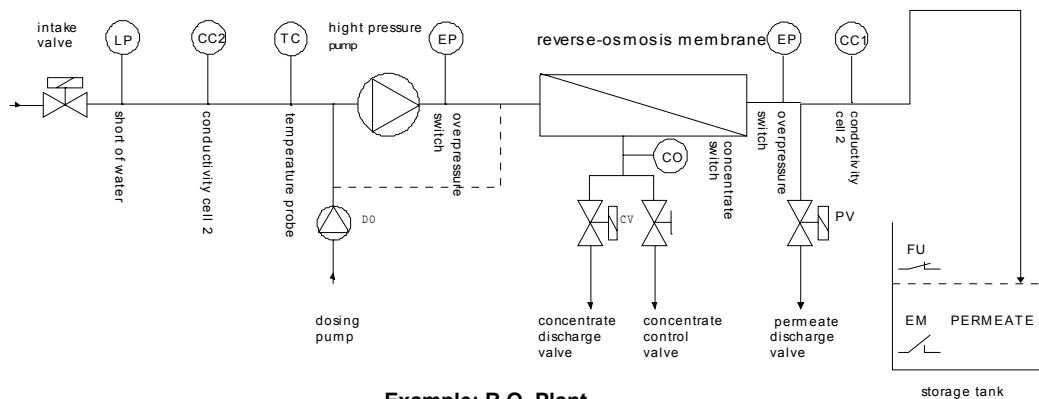

Example: R.O. Plant

Interval Rinse

It is also possible to set rinse cycles to take place at regular intervals, calculated since the last production or rinse cycle, to help prevent formation of deposits. For this purpose, it is possible to program intervals of 1-999 hours and rinse time of 1-9999 seconds. See steps 9.2 and 9.3.

Like the procedure, "Rinse before Standby mode", can be rinsed or like an other procedure for example without high pressure pump.

The following values can be monitored (if the controller is programmed to do so and the appropriate sensors are connected to the inputs):

Low pressure input
Overpressure input
Water temperature exceeds upper limit

Tank empty input
Motor protection input
Stop production input



"MAINTENANCE" mode

In "MAINTENANCE" mode, the unit can be started up and shut down in order to, for example, cleanse the membrane with special agents. By entry of a code, it is possible to prevent unauthorized personnel from switching the unit into this mode. A maximum period of 1-9999 minutes can be programmed. It is also possible to set the unit to automatically report that a maintenance cycle is required (a programmable maintenance interval of 1-65,000 hours can be set).

"STANDBY STOP" step

The high pressure pump and the cut-off valves are not driven in this position.

This message is displayed by the software the first time it is put into operation and after being updated in order to first of all programme the basic values.

This position can also be manually called (see page 46).

Otherwise it is possible to also call this function using the fault and message relay. (Application: depending upon the operational management the installation may not automatically come back into operation following a power failure).

Dosage of chemicals

Dosage of chemicals can be performed in "PRODUCTION", "RINSE" or "MAINTENANCE" mode, as desired. The dosage time can be set from 1 to 65,000 seconds or for the duration of the whole mode, however, it cannot exceed the duration of the mode in which it is performed.

Measurement of conductivity

The standard unit includes an I/O board with 1 conductivity meter for measuring the conductivity of the permeate. Optionally, instead of the standard board, a board with 2 conductivity meters and the circuitry for water temperature measurement can be installed.

The second conductivity meter can be used to measure the conductivity of water either at the inlet or at a further stage in the process.

If the second conductivity meter is used to measure conductivity at the water inlet, it is possible to calculate and display the relative conductivity of the permeate as a parameter of the degree of desalination.

The conductivity meters are capable of switching automatically between two separate ranges. The ranges are dependent upon the sensors used and can be set from very pure water of 1 $\mu\text{S}/\text{cm}$ to very saline water to 100 mS/cm .

Calculating the ranges:

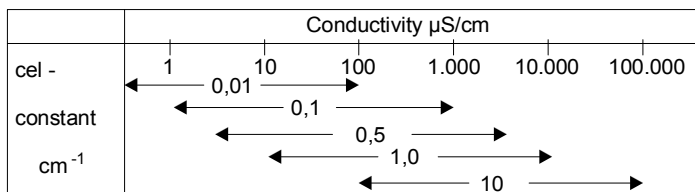

$$range_{max} = cell\ constant * 10\ 000\ \mu\text{S}$$

$$range_{min} = cell\ constant * 10\ \mu\text{S}$$

For the function control of the conductivity measurement a lower limit can be set and for the quality control of the water an upper limit can be programmed. If the lower limit is reached, a shutdown YES/NO can be programmed after a fixed delay of 60 seconds. For the upper limit, a shutdown YES/NO and a delay can be programmed if the limit is exceeded.

If the reported value is outside the programmed range, i.e., a value not between the upper and lower limits, it can be signalled via the monitoring and/or alarm relays.



Temperature measurement and compensation

If the standard adaptor board for conductivity measurement is replaced by the optional adaptor with facilities for two conductivity measurements and temperature measurement, then a temperature probe can be attached to measure temperature and temperature monitoring can be programmed; in this case, the temperature can be displayed on the LCD display.

If the standard board without temperature measurement is used, manual temperature compensation can be performed. At a temperature of 25 °C, the correction factor is 1 and no compensation is performed on the conductivity value.

Automatic correction is possible when the extended adaptor board is connected to a temperature probe.

Temperature compensation

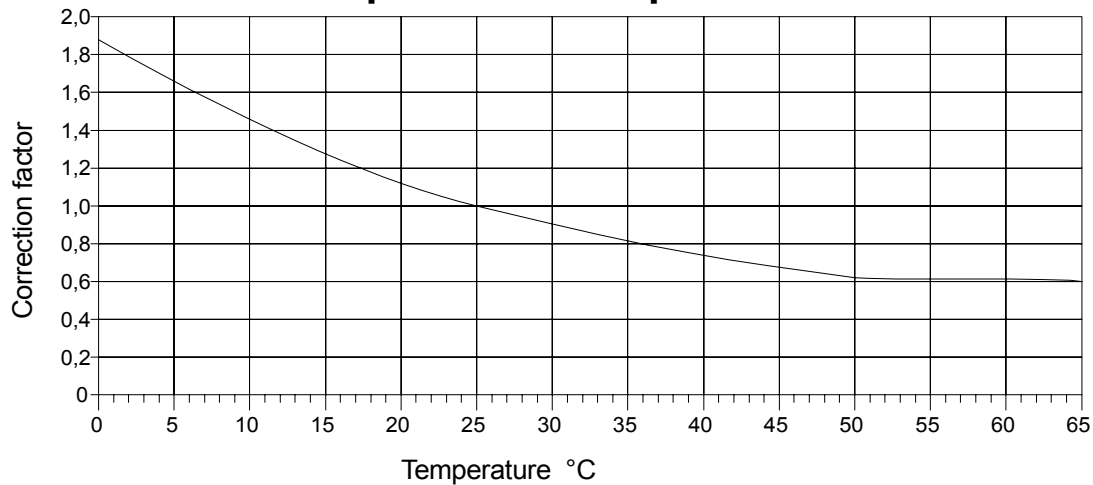

The correction factor for automatic or manual compensation can be obtained from the graph below.

Example:

Set/measured water temperature:	T = 11 °C
Measured conductivity:	C ₁₁ = 100 µS/cm
Correction factor used:	K = 1.4
Displayed conductivity:	C ₂₅ = 140 µS/cm

Illustration

Wall-mounted type OS3050

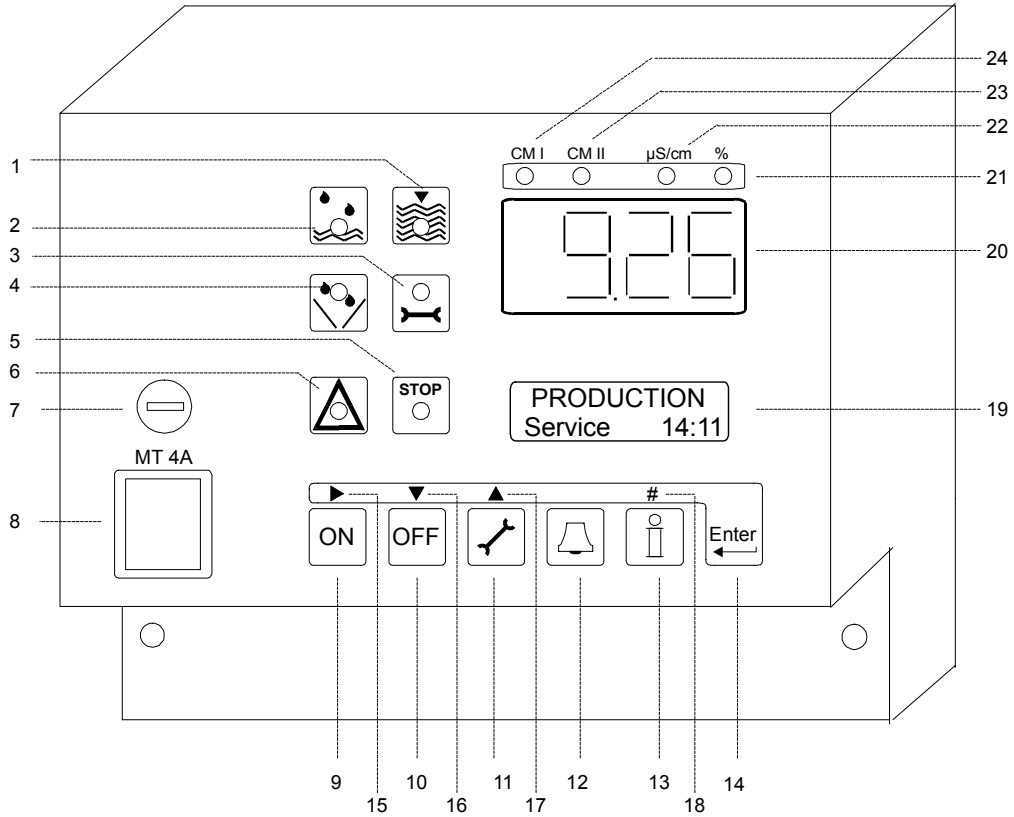

- | | | | |
|---------------------|----------------------|--------------------------|---------------------|
| 1 Led : Standby | 7 Main fuse | 13 Key : Info | 19 LCD display |
| 2 Led : Production | 8 Main switch | 14 Key : Programming | 20 LED display |
| 3 Led : Maintenance | 9 Key : ON | 15 Move cursor | 21 Unit % |
| 4 Led : Rinse | 10 Key : OFF | 16 Next program step | 22 Unit μS/cm |
| 5 Led : Alarm | 11 Key : Maintenance | 17 Previous program step | 23 Conductivity CM2 |
| 6 Led : Malfunction | 12 Key : Reset | 18 Enter numbers | 24 Conductivity CM1 |

Panel-mounted type OS3051

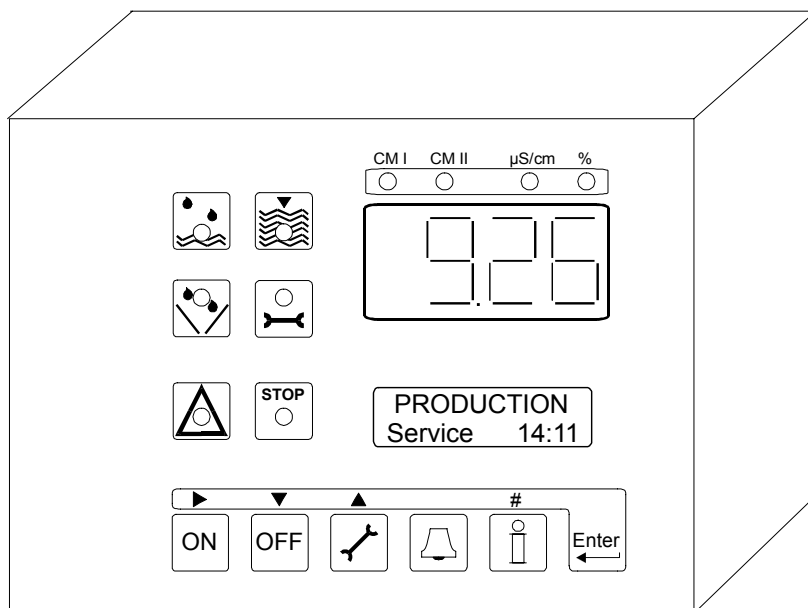

Measuring values and display of functions

LED display

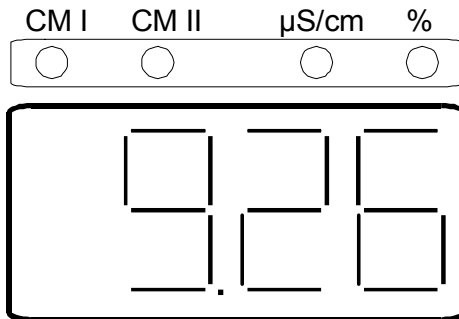

The LED display shows the value of :

Conductivity meter 1 or
 Conductivity meter 2 or the
 Relative conductivity

The values of Conductivity meters 1 and 2 are displayed in the unit $\mu\text{S}/\text{cm}$ and the relative conductivity is displayed in percentages (according to the formula : $(\text{Conductivity 1} / \text{Conductivity 2}) * 100\%$).
 If the conductivity value lies outside the measuring range, then the "OFL" (overflow) message appears on the display.

The green LED's above the display indicate the actual conductivity meter and its related unit.

LED indicator lights

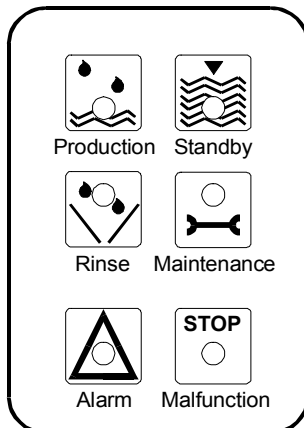

Coloured lights signal the most important modes.

Production	(green)
Standby	(green)
Rinse	(orange)
Maintenance	(orange)
Alarm	(red)
Malfunction	(red)

The LCD display provides additional information.

LCD display

Top line of LCD display

On the top line of the LCD display, the present state of the unit is given, e.g.: "PRODUCTION", "RINSE", "STANDBY" or "MAINTENANCE."

If the installation is switched off due to an alarm during one of the phases as mentioned above, the following messages can be displayed in the first line of the LCD display :

"PRODUCTION ALARM", "RINSE ALARM", "RINSE ALARM I", "MAINTENANCE ALRM".

Bottom line of LCD display

On the second line of the LCD display, measurements and operating conditions of the current condition of the unit are displayed.

NOTE: If "overflow" appears on the bottom line, then a value outside the range of the unit has been detected.

Bottom line of LCD display in "PRODUCTION" mode

PRODUCTION	
Delay	10s

On the bottom line of the LCD display, the following information is displayed during "PRODUCTION" mode:

Initially, the delay in seconds is given. This occurs until the high pressure pump is started (example: "Delay 10s").

Additionally, dependent upon how the unit has been programmed and the hardware configuration, the conductivity measurements 1 and/or 2, relative conductivity and water temperature are displayed in series. The hours of operation of the unit are given as well.

Conductivity 1	8.0	µS/cm
Conductivity 2	147.0	µS/cm
Relative conductivity	5.4	%
Temperature	24.5	°C
Operating time	114:14	h (hours:minutes)

Bottom line of LCD display in "RINSE" mode

RINSE	I
Rinsetime	600s

On the bottom line of the LCD display, the remaining rinse time is displayed during "RINSE" mode.

If the letter " I " is placed in the right upper corner then a programmed automatic rinse at regular intervals of the membrane is in progress.

Otherwise, it applies to a rinse after the unit has been placed in "STANDBY" mode.

Dependent upon how the unit has been programmed and the hardware configuration, the conductivity measurements 1 and/or 2, relative conductivity and water temperature are displayed in series. The hours of operation of the unit are given as well.

Conductivity 1	8.0	µS/cm
Conductivity 2	147.0	µS/cm
Relative conductivity	5.4	%
Temperature	24.5	°C
Operating time	114:14	h (hours:minutes)
Produc. Man. Off		Stopped by hand

Bottom line of LCD display in "STANDBY" mode

STAND BY Service 114:14
--

Dependent upon how the unit has been programmed and the hardware configuration, in "STANDBY" mode, the conductivity measurements 1 and/or 2, relative conductivity and water temperature are displayed in series. The hours of operation of the unit are given as well.

Conductivity 1	8.0	µS/cm
Conductivity 2	147.0	µS/cm
Relative conductivity	5.4	%
Temperature	24.5	°C
Operating time	114:14	h (hours:minutes)
Produc. Man. Off		Stopped by hand

Bottom line of LCD display in "MAINTENANCE" mode

MAINTENANCE ON Maint.time 120m

During "MAINTENANCE" mode, the bottom line of the LCD displays the remaining time of operation of the high pressure pump, in minutes:

Time remaining 120m

Additionally, dependent upon how the unit has been programmed and the hardware configuration, the conductivity measurements 1 and/or 2 and water temperature are displayed in series. The hours of operation of the unit are given as well.

Conductivity 1	8.0	µS/cm
Conductivity 2	147.0	µS/cm
Temperature	24.5	°C



INFO - display

By pressing the information key, information and values can be displayed. Changing values are described, where possible, under "Display and Modification of Setpoints."

Press the information key  to display the first item of information. Each press of the key then advances to the next item of information.

Input states - 1

Input 1
ST0 FU0 EM0 EP0

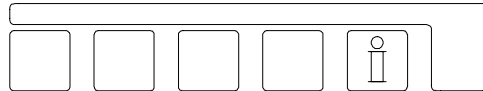

The present states of inputs ST, FU, EM and EP are displayed. A "1" next to the code means that the input is activated, a "0" that it is inactive. Input EM is normally open, i.e., it is activated when the circuit is closed. Inputs ST, FU and EP are normally closed, i.e., are activated when the circuit is opened.

ST = stop FU = full EM = empty EP = overpressure

Input states - 2

Input 2
LP0 CO0 PS0



The present states of inputs LP, CO, and PS are displayed. A "1" next to the code means that the input is activated, a "0" that it is inactive. Inputs LP, CO and PS are normally closed, i.e., are activated when the circuit is opened.

LP = inlet pressure low CO = concentrate PS = motor safeguard

Output states

Output 1234567
| | - - - - -

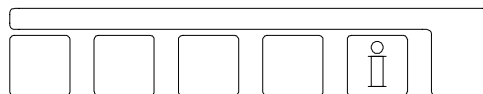

The present states of the output relays are displayed. Each cipher is assigned to a relay (see electrical diagram relays K1-K7).

A horizontal line ("-") under a cipher means that the relay is not activated.
A vertical line ("|") under a cipher means that the relay has been activated.

Service phone number

Service
0031 73 443755

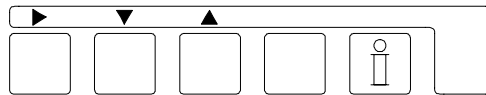

The telephone number for requesting service is displayed.

To change the telephone number:

Select number: push key with "▶" symbol
Increment number push key with "▲" symbol
Decrease number: push key with "▼" symbol

Software version

Softwareversion
OS3050 3.04.01g

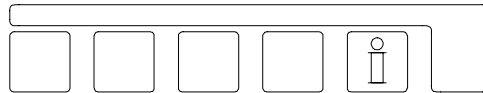

Software is updated regularly in the factory. As required, changes are incorporated in order to reflect new developments and requirements. The installed version is displayed.

Alarm relays A-H

Alarm ABCDEFGH
On/Off -- | | ----

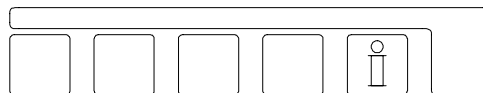

This displays which alarms are programmed to activate the alarm relay.

A horizontal line (dash or "-") under a letter means that the relay is not programmed to trip the alarm. A vertical line ("|") under a letter means that the relay is programmed to trip the alarm.

A(1) = CM 1 MIN	E(5) = Tank Full
B(2) = CM 1 MAX	F(6) = Overpressure
C(3) = Stop	G(7) = Low pressure
D(4) = Tank Empty	H(8) = Concentrate

Alarm relays I-P

Alarm	IJKLMNOP
On/Off	-- - - - -



This displays which alarms are programmed to activate the alarm relay.

A horizontal line ("-") under a letter means that the relay is not programmed to trip the alarm. A vertical line ("|") under a letter means that the relay is programmed to trip the alarm.

I(9) = Motor safeguard	M(13) = CM 2 MAX
J(10) = Power failure	N(14) = CM % MIN
K(11) = Maintenance	O(15) = CM % MAX
L(12) = CM 2 MIN	P(16) = Temperature

Malfunction relays A-H

Malfunc	ABCDEFGH
On/Off	-- - - - -

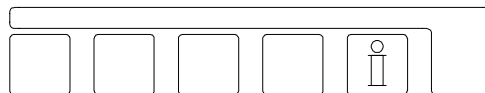

This displays which malfunctions are programmed to activate the malfunction relay.

A horizontal line (dash or "-") under a letter means that the relay is not programmed to trip the alarm. A vertical line ("|") under a letter means that the relay is programmed to trip the alarm.

A(1) = CM 1 MIN	E(5) = Tank Full
B(2) = CM 1 MAX	F(6) = Overpressure
C(3) = Stop	G(7) = Low pressure
D(4) = Tank Empty	H(8) = Concentrate

Malfunction relays I-P

Alarm	IJKLMNOP
On/Off	- - - - - -

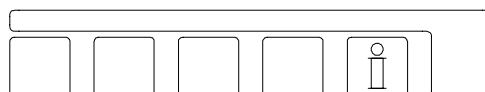

This displays which malfunctions are programmed to activate the malfunction relay.

A horizontal line ("-") under a letter means that the relay is not programmed to trip the alarm. A vertical line ("|") under a letter means that the relay is programmed to trip the alarm.

I(9) = Motor safeguard	M(13) = CM 2 MAX
J(10) = Power failure	N(14) = CM % MIN
K(11) = Maintenance	O(15) = CM % MAX
L(12) = CM 2 MIN	P(16) = Temperature

Rinse interval

Rinse interval
24h* 16h 300s**

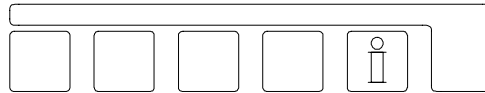

The following is displayed:

1. Programmed rinse interval (time between rinse cycles)
2. Remaining rinse time
3. Duration of rinse cycle

If no rinse interval is programmed, "no rinse interval" is displayed.

Concentrate rinse

Concentr. rinse
600s

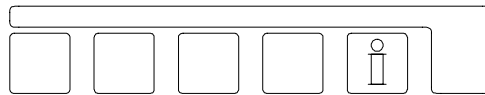

The duration of the concentrate rinse cycle after switching to "STANDBY" mode is displayed.

Cell constant

Celconstant
C1=0.10 C2=0.50

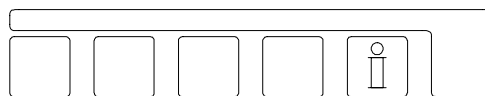

The display shows the cell constant for conductivity meter 1 (C1) entered in program step 1.2 and if the plug-in card with the second conductivity meter has been installed, the cell constant (C2) entered in program step 2.2 is shown.

Maintenance interval

Mainten.interval
500h 500h



The duration of the time between scheduled maintenance stops and the time remaining until the next maintenance stop is displayed.

Temperature

Watertemperature
Autom. 15°C/80°C

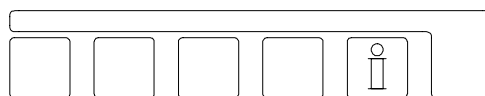

Here the measured water temperature as well as any programmed max. threshold limit value are displayed, in as far as a plug-in expansion card has been installed and the temperature probe has been connected. In the other case the temperature entered in program step 4.1 is displayed ("Man. 25°C")

Manual Operation

"PRODUCTION" mode

Usually, the unit is switched into and out of operation by the level gauges in the storage tank. If no storage tank is present, or if the storage tank is not full, then the unit can be switched into operation manually.

Press the "ON" key (the key marked ) LED marked "PRODUCTION" illuminates and production starts.

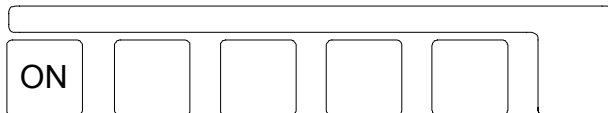

If the level gauge on the storage tank activates the "tank full" relay when an operator tries to start manual operation, the message "Tank FULL" appears on the LCD display, and "PRODUCTION" mode cannot be started.

ATTENTION : If the production is stopped by hand (OFF key) then the production will only start after pressing the ON key.

"STANDBY" mode

"PRODUCTION" mode can be manually terminated by pressing the "OFF" key (the key marked ). After 4 seconds, the LED marked "OFF" illuminates and production stops.

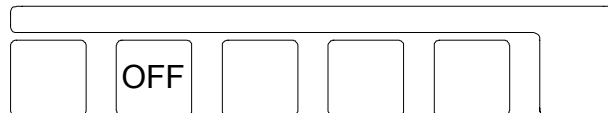

If automatic rinse has been programmed, then, before "STANDBY" commences, the LED marked "RINSE" is lit for the duration of the rinse cycle. If, however, the storage tank is empty, the message "Tank EMPTY" appears on the LCD display and production cannot be stopped.

ATTENTION : If the production is stopped by hand (OFF key) then the production will only start after pressing the ON key.

"MAINTENANCE" mode

"MAINTENANCE" mode can only be entered from "STANDBY" mode, therefore, first switch the unit to "STANDBY", and then press the "MAINTENANCE" key (the key marked ).

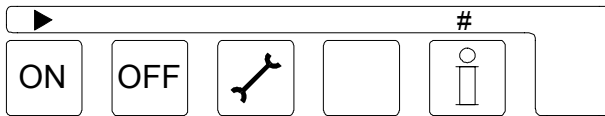

If no access code has been programmed for this step, after a 5 second delay, the "STANDBY" mode" LED does not illuminate any more.



If an access code has been programmed, then first enter the code using the keys "▶" and "#", keeping  pressed.

Use the keys "ON" and "OFF" to start and stop the maintenance program. The program will stop automatically after the maintenance time programmed in step 16.4.

To return to "STANDBY" mode, press the "MAINTENANCE" key (the key marked ) once again.



ATTENTION! Only trained maintenance personnel should operate the unit in "MAINTENANCE" mode.

Terminate "RINSE"

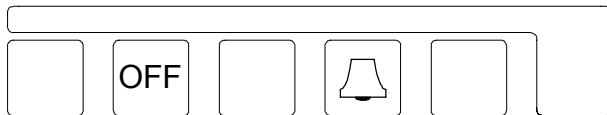
To terminate a rinse cycle before its programmed completion, press the "OFF" and "RESET" keys (the keys marked  and ) simultaneously. After 5 seconds, the rinse cycle is stopped.



Start "Interval Rinse"

If in step 9.1 the function "Interval Rinse" is programmed and the installation is in the "Standby mode", the "Interval rinse" can be started by pressing simultaneously the keys "OFF" and "RESET" (the keys marked  and ) for 5 seconds. The programmed time distance will be reset.

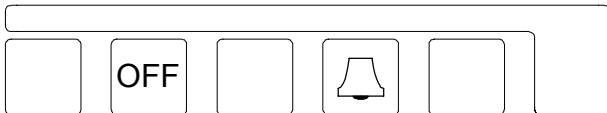

Tip: if step 8.1 "Rinse before Standby" is programmed with "YES", the "Rinse before Standby" can be started by activating for a moment the Production mode for a moment and next to change over to the Standby mode.

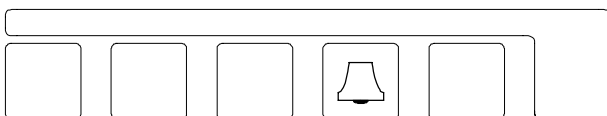

Reset ALARM / MALFUNCTION

If an ALARM or MALFUNCTION has triggered the associated relays, they can be reset by pressing the key with the  symbol. This turns off the ALARM and/or MALFUNCTION LED's.





Alarms / malfunctions

If an alarm and/or malfunction relay has been programmed, these can be switched off by pressing the key . Once the cause of the message has been cleared, the message on the LCD display can be cleared by once again pressing the key .

CM 1 MIN

**Limit CM1 Min
under valued**

The conductivity measured by conductivity meter 1 has fallen below the programmed minimum. A shutdown YES/NO can be programmed (fixed delay of 60 seconds). The alarm is turned off as soon as conductivity rises above the minimum value.

It is possible to temporarily reactivate the unit by pressing the "ON" key. Possible causes: changes in water quality, air in sensor 1 or an interruption in power to sensor 1.

CM 1 MAX

**Limit CM1 Max
exceeded**

The conductivity measured by conductivity meter 1 exceeds the programmed maximum. A shutdown YES/NO and delay can be programmed. The alarm is turned off as soon as conductivity falls below the maximum value.

It is possible to temporarily reactivate the unit by pressing the "ON" key. Possible causes: changes in water quality, setting of sensor 1 changed, defective membrane or a short-circuit in sensor 1.

CM 2 MIN

**Limit CM2 Min
under valued**

The conductivity measured by conductivity meter 2 has fallen below the programmed minimum. A shutdown YES/NO can be programmed. The alarm is turned off as soon as conductivity rises above the minimum value.

It is possible to temporarily reactivate the unit by pressing the "ON" key. Possible causes: changes in water quality, air in sensor 1 or an interruption in power to sensor 2.

CM 2 MAX

**Limit CM2 Max
exceeded**

The conductivity measured by conductivity meter 2 exceeds the programmed maximum. A shutdown YES/NO and delay can be programmed. The alarm is turned off as soon as conductivity falls below the maximum value.

It is possible to temporarily reactivate the unit by pressing the "ON" key. Possible causes: changes in water quality, setting of sensor 1 changed, defective membrane or a short-circuit in sensor 2.

CM% MIN

**Limit CM% Min
under valued**

The relative conductivity measured has fallen below the programmed minimum. The alarm is turned off as soon as the relative conductivity rises above the minimum value.

Possible causes: changes in water quality, air in sensor 1, an interruption in power to sensor 1 or sensor 2 short-circuited.

CM% MAX

**Limit CM% Max
exceeded**

The relative conductivity measured exceeds the programmed maximum.

A shutdown YES/NO and delay can be programmed. The alarm is turned off as soon as the relative conductivity falls below the maximum value.

It is possible to temporarily reactivate the unit by pressing the "ON" key. Possible causes: changes in water quality, settings of the unit changed, defective membrane or a short-circuit in sensor 1, air in sensor 2 or an interruption in power to sensor 2.

Stop

**Signal
Stop**

The stop input is activated and water production is interrupted.

As soon as the stop input is deactivated, water production is continued. The message is switched off, insofar as the message or fault relay are not activated. Then the display must be cancelled by pressing the  key.

You can quickly switch on the installation by pressing the "ON" key.

Start by hand

**Handstart
Stop**

The stop input is activated and water production is interrupted.

The installation can only be started when the stop input is no longer active and the "ON" key is pressed. In so doing, the display and any programmed message and fault relay are cancelled.

Tank Full

**Tank
Full**

This alarm occurs when attempting to start the unit by pressing the "ON" key although the level sensor measures "Tank Full."

Allow the storage tank to empty before reattempting to restart production.

Check the level sensor in the storage tank.

The display also appears, if you have selected "Y" at programming step 13.5 or 14.5 when the "FULL" level switch, connected across terminals 25 and 26, gives open contact

Tank Empty

**Tank
Empty**

The storage tank is empty. The alarm shuts off as soon as the tank is filled.
Possible causes: Water is removed too quickly from the tank.

This alarm can only occur if only one maximum level gauge is used to measure the fill-level of the tank and the minimum level gauge is used to measure the low level (see step 11 of basic programming).

The display also appears, if you have selected "Y" at programming step 13.4 or 14.4 when the "EMPTY" level switch, connected across terminals 27 and 28, gives closed contact.

Overpressure

**Signal
Overpressure**

The "Overpressure" input is activated. The unit is shut down. The alarm is deactivated and the unit restarted as soon as the "Overpressure" signal ends and the unit is manually restarted.

It is possible to temporarily reactivate the unit by pressing the "ON" key.

Possible causes: settings of unit changed, membrane heavily fouled or a concentrate line valve closed.

Low pressure 1

**Signal
Low pressure 1**

The "Low pressure" input is activated. The unit is shut down and, after a programmed delay, the unit is reactivated in accordance with the instructions set in steps 12.2 and 12.3 of the basic programming.

The alarm is deactivated as soon as the "low pressure" signal ends. It is possible to temporarily reactivate the unit by pressing the "ON" key. Possible cause: no water pressure, blocked filters.

Low pressure 2

**Signal
Low pressure 2**

The "Low pressure" input is activated. The unit can be shut down. The alarm is deactivated and the unit restarted as soon as the "low pressure" signal ends. If at the same time the "Alarm" or "Malfunction" relays are tripped, then the alarm must be manually turned off.

This alarm can only occur if the value "0" is set in step 12.2 of the basic programming. It is possible to temporarily reactivate the unit by pressing the "ON" key. Possible cause: no water pressure, blocked filters

Low pressure 3

Signal
Low pressure 3

The "Low pressure" input is activated.

The unit is shut down. The alarm is deactivated and the unit restarted as soon as the "low pressure" signal ends and the unit is manually restarted.

This alarm occurs when it is attempted to automatically restart the unit in spite of low pressure or if in the value "1" is set in step 12.2 of the basic programming.

It is possible to temporarily reactivate the unit by pressing the "ON" key. Possible cause: no water pressure, blocked filters.

Concentrate 1

Signal
Concentrate 1

The "Concentrate" input is activated.

The unit is shut down and restarted automatically in accordance with the instructions set in steps 7.2 and 7.3 of the basic programming.

The alarm is deactivated and the unit restarted as soon as the "concentrate" signal ends and the unit is manually restarted.

It is possible to temporarily reactivate the unit by pressing the "ON" key. Possible cause: Changes to unit settings.

Concentrate 2

Signal
Concentrate 2

The "Concentrate" input is activated.

The unit is shut down. The alarm is deactivated and the unit restarted as soon as the "concentrate" signal ends. This alarm can only occur if the value "0" is set in step 7.2 of the basic programming.

It is possible to temporarily reactivate the unit by pressing the "ON" key. Possible cause: Changes to unit settings.

Concentrate 3

Signal
Concentrate 3

The "Concentrate" input is activated.

The unit is shut down. The alarm is deactivated and the unit restarted as soon as the "concentrate" signal ends and the unit is manually restarted.

This alarm occurs when it is attempted to automatically restart the unit in spite of a concentrate alarm. It is possible to temporarily reactivate the unit by pressing the "ON" key. Possible cause: Changes to unit settings.

Motor safeguard switch

**Signal
Motorprotection**

The "Motor safeguard" input is activated. The unit is shut down. The alarm is deactivated and the unit restarted when the motor safeguard switch is reset.

Possible causes: Changes to unit settings, malfunction in the unit, motor overheating

Temperature MAX

**Limit Temp. Max
exceeded**

The programmed maximum limit is exceeded. The unit is not shut down. The alarm is deactivated as soon as the temperature drops below the upper limit.

Power failure

**Signal
Supply fail.**

No power to the unit or the unit is shut off. The alarm is deactivated when the "RESET" key (the key with the  symbol) is pressed. This alarm only occurs if, in steps 13.10 or 14.10 of the program an alarm or malfunction relay for power failure is activated.

NOTE: All programmed values and the values of the internal clock are stored in non-volatile memory and are retained in the event of a power failure.

Standby stop

**STAND BY
STOP**

The high pressure pump and the cut-off valves are not driven in this position.

Exception: when altering the program steps 8.4, 9.5 and 17.1. The following actions can be carried out:

1. Programming the basic values;
2. Calling the info data;
3. Switching the "MAINTENANCE" step on and off;
4. Starting production;
5. Stopping production or starting a rinse;
6. Cancelling the fault and message relay.

Once the "ON" key for production start or the "OFF" key for production stop has been pushed, the "STANDBY STOP" function is cancelled and then when switching on the mains power switch another time, a normal start follows, which generally starts with a rinse.



Output functions

High pressure pump/three-phase regulator

The **high pressure pump** is connected to pins "PU." The voltage at this point is the same as the unit's main power connection. The maximum load of the controller, including solenoid valves connected to it, may not exceed 4.0 A.

The unit can be supplied with an (optional) thermal protector.

Larger units are often fitted with pumps using three-phase motors. Power is supplied to the pumps via a fused **three-phase adaptor** connected to "PU".

The adaptor must be installed outside the controller. It is recommended to use a switchbox with the internal model (OS3051). The switchbox can be used for multiple three-phase adapters for pumps, thermal protectors, time-delay relays, star-delta starters, alarm and signal lights, etc.

Power to the high pressure pump is started after a delay following opening of the inlet and concentrate discharge valves in "PRODUCTION" mode and or after opening the concentrate discharge valve in "RINSE" mode. A delay of 1-999 seconds can be set in programming step 6.1

Inlet valve

The inlet valve is connected to pins "IV." The voltage at this point is the same as the unit's main power connection. The inlet valve opens when power is applied.

Concentrate discharge valve

The concentrate rinse valve is connected to pins "CV." The voltage at this point is the same as the unit's main power connection. The concentrate discharge valve opens when power is applied.

Permeate valve

Dependant upon the way the valve is fitted and connected to the "PV" terminals, it can function either, as a purge valve, or, as a permeate valve.

Normally open purge valve -	connect across terminals 11 and 13.
Normally closed purge valve -	connect across terminals 11 and 12.
Normally open permeate valve -	connect across terminals 11 and 12.
Normally closed permeate valve -	connect across terminals 11 and 13.

In the "**Production**" mode the purge valve will be opened and the permeate valve closed.

ATTENTION: if you have set a limit, at programming step 1.6, these valves will change over whenever the limit is exceeded.

In the "**Purge**" mode the purge valve will be open, and the permeate valve closed.

The valve function in the "**Standby**" mode is selected at programming step 17.1 .

The valve function in the "**Maintenance**" mode is selected at programming step 16.5 .



Dosing pump

The "dosing pump" output is an ungrounded (single-edged) output marked "DO." This can be used for an ungrounded control connection for dosing units or, with special wiring, a direct connection to a dosing pump.

It is also possible to use this output for a return valve for concentrate or permeate.

The output can be activated during "PRODUCTION", "RINSE" or "MAINTENANCE" mode.

It is possible to limit dosing to between 1 and 65,000 seconds, however, the time may not exceed the duration of the mode in which it occurs.

If step 10.1 is programmed at No this output will be switched parallel to the output PU.

Alarm Relay

The alarm relay output is an ungrounded (single-edged) output marked "AN." When no power is applied, the relay is in the state: no alarm.

The sources of an alarm can be programmed.

Malfunction Relay

The malfunction relay output is an ungrounded (single-edged) output marked "MF." When no power is applied, the relay is in the state: malfunction.

The sources of a malfunction can be programmed.

Recorder Output

In order to use this output, the unit must be supplied with an optional I/O board for connection to a printer-recorder (oscillograph). The recorder must be capable of accepting inputs of 0-20 or 4-20 mA.

The following signals can be received via the recorder output:

- Value conductivity meter 1
- Value conductivity meter 2
- Value relative conductivity 1
- Water temperature

The measurement range can be programmed.

If more than one value is routed to the output, then each value is transmitted for a period of 20 seconds, in cycle



Input functions

STOP

The connection from the „STOP“ input is marked with „ST“ and is active (closed or opened) depending on the programming of step 18.2. In the event of a STOP message, water production is stopped after approximately 6 seconds.

If the program step 18.1 “Stop Hand start” is set to YES, then the message follows in the LCD display: "Signal start by hand". The installation has to be re-started again by pressing the “ON” key.
Application: e.g. an external fault, which requires a manual intervention.

If the program step 18.1 “ Stop Hand start ” is set to NO, then the message follows in the LCD display: "Signal STOP". The installation continues its normal function, as soon as the stop signal to the input is cancelled. The installation can also be switched on in the event of a stop signal by pressing the “ON” key.
Application: e.g. no production during regeneration of a pre-switched water softening installation.

The stop signal can be switched on the message relay and/or the fault relay.
If no stop switch is connected, then the input must be bridged.

See also: Faults / Messages page 16

WARNING: The stop function does not interrupt the “MAINTENANCE” function.

Tank full / empty

The connections for the level switches for automatically filling the storage tank are marked "FU" (full) and "EM" (empty). Input "FU" is **active when open** and input "EM" is **active when closed**. If both signals are received simultaneously, only the "HIGH" signal is responded to. In other words, if the tank is empty, both level switches are closed.

Filling the tank can be done using the "full" level switch. The "empty" level switch is then used as a "minimum level" alarm. Alternatively, filling can be accomplished using both switches or manually (see program step 11.1).

The "FULL" and "EMPTY" signals can be connected to the alarm and/or malfunction relays, in which case they are also displayed on the LCD.

The inputs are polled every 4 seconds.

High pressure

The input for a pressure switch is marked "EP" and is **active when open**. It is polled every 4 seconds. Multiple pressure switches can be connected in series. A signal is displayed on the LCD and can be connected to the alarm and/or malfunction relays.

To turn the unit on again, you must press the "ON" key. If pressure is still too high, the unit is shut off again after 4 seconds. If no pressure switch is connected, contact "EP" must be shorted



Low pressure

To prevent the pump running dry, a pressure switch can be used. The input for this pressure switch is marked "LP" and is **active when open**. A delay of 1-999 seconds can be programmed in step 12.1. Furthermore, it is possible to program the unit to attempt to restart from 0 to 9 times. After this series, the unit can only be restarted by pressing the "ON" key.

A signal is displayed on the LCD and can be connected to the alarm and/or malfunction relays. If no pressure switch is connected, contact "LP" must be shorted.

Concentrate low flow

To monitor concentrate flow, a flow sensor with an ungrounded (single-edged) input can be used. The connection for this sensor is marked "CO" and is **active when open**. A delay of 1-999 seconds can be programmed in step 7.1. Furthermore, it is possible to program the unit to attempt to restart from 0 to 9 times. After this series, the unit can only be restarted by pressing the "ON" key.

A signal is displayed on the LCD and can be connected to the alarm and/or malfunction relays. If no flow switch is connected, contact "CO" must be shorted.

Reset alarm

To be able to remotely reset the alarms, the 'CO' input can be programmed for a reset function. In program stage 7.0, the 'RS' function should be selected, replacing the input function for concentrate security.

The input should be short-circuited for at least 1 second, after which the reset will be executed and the installation will automatically be switched on.

The alarm outputs and messages in the LCD display are erased as soon as the reset is executed. However, the alarm outputs and messages in the display will not be erased and the installation will not be switched on if the cause of the alarm is still present. If the alarm has been erased manually, the 'reset' function will not be checked remotely until an alarm with activated alarm output occurs again.

Motor Safeguard Switch

The input for a motor safeguard switch is marked "PS" and is **active when open**. It is polled every 2 seconds. Multiple switches can be installed in series.

In models operating at up to 240 V a thermal protector can be optionally supplied. The contact for the thermal switch is connected internally in the controller.

A signal is displayed on the LCD and can be connected to the alarm and/or malfunction relays. The thermal protector or motor safeguard switch must be manually reset, after which the unit will be reactivated automatically. If no safeguard switch is connected, contact "PS" must be shorted.

Conductivity sensor 1 and 2

The inputs for the conductivity sensors for the conductivity meters are marked "CC1" and (optional) "CC2." Ensure that the correct cell constant is set in program steps 1.2 and 2.2.

Temperature sensor

A PT 1000 platinum resistance thermometer must be used. The connection is marked "TC." The temperature sensor can be built into the conductivity sensor or installed separately next to it.

If no temperature sensor is installed, then all calculations are performed using a temperature of 25 °C. This also occurs by a closure or break in the circuit



Display and modification of setpoints

During installation, the controller of the reverse osmosis unit is programmed by setting its setpoints. These values can be changed at any time, however, note that they are not lost in the event of a power failure.

Changes to setpoints should only be made by authorized and trained technicians.

Record the setpoints in the empty fields in the following program diagram and place this manual in safe keeping for use by operators and maintenance personnel.

Setpoint changes may be made at any time.

Some keys have a double function. In program mode, the keys "▶", "▼", "▲" and "#" are used in combination with the key "ENTER."

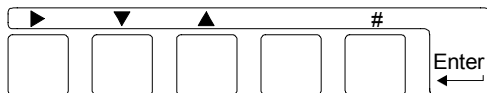

1. Press the "ENTER" key. In order to prevent inadvertent changes to the program, the key must be held down for 4 seconds before changes to the program may be made.

Initially, the following is displayed in the LCD display:

Attention!
Programmechange

Followed after 4 seconds by this message:

Start
Programmechange

NOTE: To perform steps 2 and 3, the "ENTER" key must be kept pressed.

Change language

2. You may now change the language used for display in the LCD as follows:
Press "#" (and keep it held down) while using the "▶" key to advance the cursor through the selection of languages until the desired language is selected.
The "ENTER" key should only be pressed when you are ready to exit this mode.

Programming setpoints :

3. The following steps can be performed if the "▼" key is held down.
4. The controller is now in programming mode. The "ENTER" key should only be pressed when you are ready to exit this mode. Programming mode is also automatically terminated approximately 2 minutes after the last keystroke.
5. Use the "▲" key to return to the program.
6. Use the "▶" key to move the cursor. For "YES/NO" decisions, move the cursor under **Y** to answer YES and to **N** to answer NO.
7. Press the "#" key to change numerical values, which you have marked using the cursor, within the set range.

1. Conductivity meter 1

The sensor is preferably installed in the permeate piping

Step no.:	1.1
Display	L<u>C</u>D <u>L</u>ED

Conductivity values can be displayed by placing the cursor either under the **LCD** or the **LED**.

NOTE: If CM2, CM% or temperature are displayed on the same output device, each value is displayed for 2 seconds, in cycle

Step no.:	1.2
Constant	0.1<u>0</u>

Depending on the conductivity values to be monitored, a sensor with a suitable cell constant must be selected.

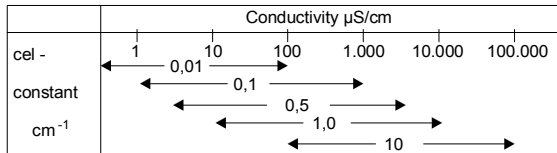

A cell constant between 0.01 up to 10.00 cm⁻¹ can be set here.

Step no.:	1.3
Limit Min	Y/<u>N</u>

This enables monitoring of conductivity values which are below a set minimum.

Step no.:	1.4
Value Min	1.0<u>0</u>

An interruption in power to the sensor, electrical faults or air in the sensor can cause measurements of extremely low conductivity to occur. A minimum value **MIN** of 0.1 up to 999 $\mu\text{S}/\text{cm}$ can be set.

After a fixed delay of 60 seconds, the LCD displays the message: "Limit CM1 MIN under valued."

Setting the alarm relay or malfunction relay is performed in steps 13 and 14

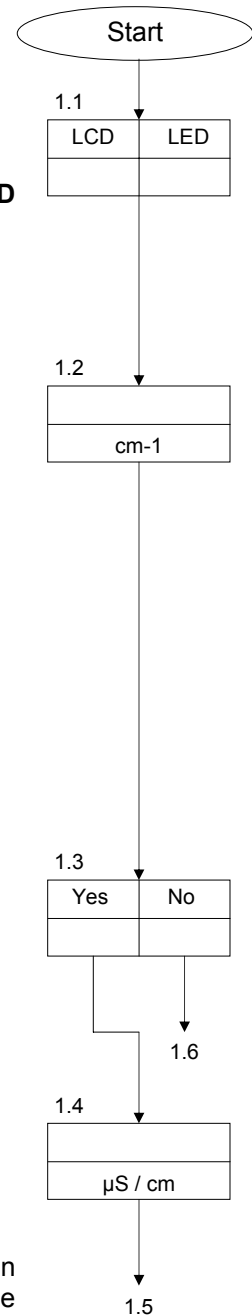

Step no.:	1.5
Switch off	Y/<u>N</u>

This enables setting whether the unit should be shut down when a value less than the setpoint for MIN is recorded.

Step no.:	1.6
Limit Max	<u>Y</u>/N

This enables monitoring of conductivity values which are above a set maximum.

NOTE: If no maximum limit is set, control of the permeate valve is not dependent upon conductivity

Step no.:	1.7
Value Max	10.<u>0</u>

Changes in the quality of the feed water for the unit can affect conductivity. A maximum value **MAX** can be set of 0.2 up to 6'500.0 $\mu\text{S}/\text{cm}$.

NOTE: This value must be greater than MIN.

Step no.:	1.8
Switch off	Y/<u>N</u>

This enables setting whether the unit should be shut down when a value in excess of the setpoint for MAX is recorded.

Step no.:	1.9
Delay	180<u>s</u>

If the MAX setpoint is exceeded, after a programmed delay of between 1 and 9'999 seconds, the message "Limit CM1 MAX exceeded" is displayed on the LCD and, if programmed, the unit is shut down.

Setting the alarm relay or malfunction relay is performed in steps 13.2 and 14.2

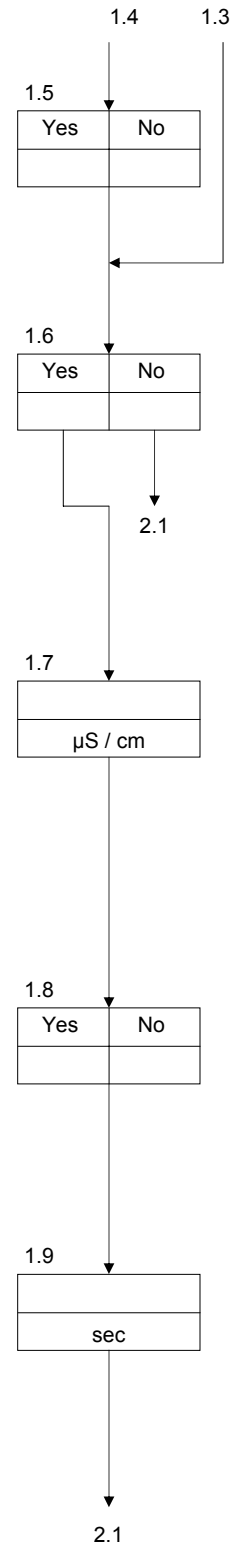

2. Conductivity meter 2

NOTE: This step can only be performed if the controller is fitted with a board for the second conductivity meter. The sensor is installed either in the feed water line or after an extra treatment phase

Step no.: 2.1
Display LCD LED

Conductivity values can be displayed by placing the cursor either under the **LCD**, the **LED** or suppressed if the cursor is not displayed.

NOTE: If CM1, CM% or temperature are displayed on the same output device, each value is displayed for 2 seconds, in cycle

Step no.: 2.2
Constant 0.10

Depending on the conductivity values to be monitored, a sensor with a suitable cell constant must be selected.

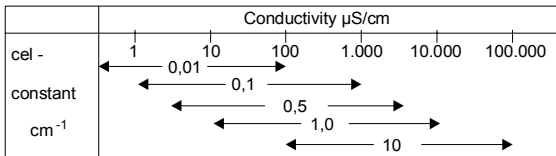

A cell constant between 0.01 up to 10.00 cm⁻¹ can be set here.

NOTE: With cell constants higher than 1.0 cm⁻¹, conductivity values greater than 9'999 µS/cm can only be displayed in the LCD.

Step no.: 2.3
Limit Min Y/N

This enables monitoring of conductivity values which are below a set minimum.

Step no.: 2.4
Value Min 5.00

An interruption in power to the sensor, electrical faults or air in the sensor can cause measurements to occur of extremely low conductivity.

A minimum value **MIN** can be set.

If the cell constant is up to 0,1 cm⁻¹: 0,1 up to 999 µS/cm
 and greater then 0,1 cm⁻¹: 1 up to 65'000 µS/cm.

After a fixed delay of 60 seconds, the LCD displays the message: "Limit CM2 MIN under valued."

Setting the alarm relay or malfunction relay is performed in steps 13 and 14.

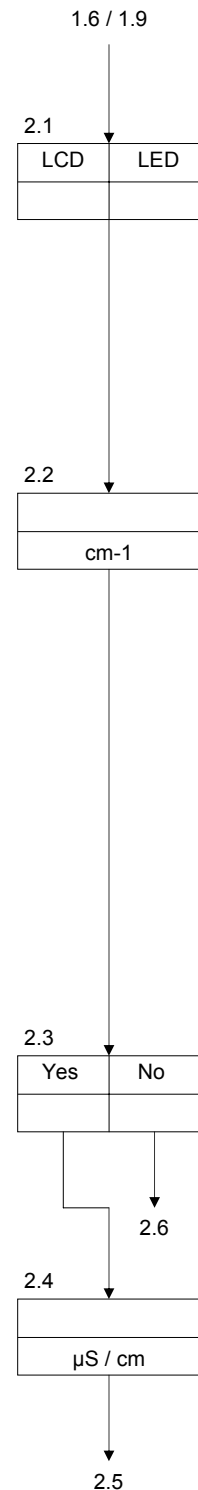

Step no.:	2.5
Switch off	Y/<u>N</u>

This enables setting whether the unit should be shut down when a value less than the setpoint for MIN is recorded.

Step no.:	2.6
Limit Max	Y/<u>N</u>

This enables monitoring of conductivity values which are above a set maximum.

NOTE: If no maximum limit is set, control of the permeate valve is not dependent upon conductivity

Step no.:	2.7
Value Max	20.<u>0</u>

Changes in the quality of the feed water for the unit can affect conductivity. A maximum value **MAX** can be set of 0.2 up to 6'500.0 $\mu\text{S}/\text{cm}$. With cell constants higher than 0.1 cm^{-1} a maximum value **MAX** can be set of 10 to 199'990 $\mu\text{S}/\text{cm}$

NOTE: This value must be greater than MIN

Step no.:	2.8
Switch off	Y/<u>N</u>

This enables setting whether the unit should be shut down when a value in excess of the setpoint for MAX is recorded.

Step no.:	2.9
Delay	180<u>s</u>

If the MAX setpoint is exceeded, after a programmed delay of between 1 and 9'999 seconds, the message "Limit **CM2 MAX** exceeded" is displayed on the LCD and, if programmed, the unit is shut down.

Setting the alarm relay or malfunction relay is performed in steps 13.13 and 14.13

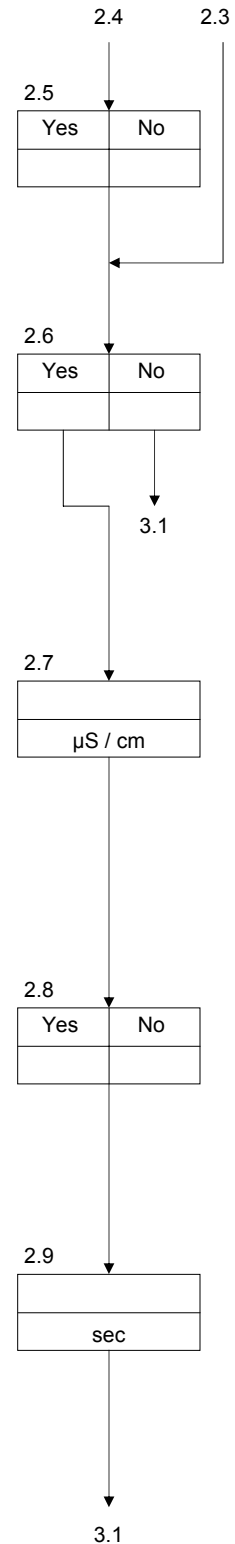

3. Relative conductivity

NOTE: This step can only be performed if the controller is fitted with a board for the second conductivity meter.

The value is displayed as a percentage of conductivity 2. The formula for the calculation is as follows:

$$\frac{\text{conductivity 1}}{\text{conductivity 2}} 100 = \text{display} [\%]$$

and is a measure of the degree of desalination. The lower the value, the lower the salt passage through the membrane.

Step no.:	3.1
Display	LCD LED

Conductivity values can be displayed by placing the cursor either under the LCD, the LED or suppressed if the cursor is not displayed.

NOTE: If CM1, CM2 or temperature are displayed on the same output device, each value is displayed for 2 seconds, in cycle.

Step no.:	3.2
Limit Min	Y/<u>N</u>

This enables monitoring of relative conductivity values which are below a set minimum.

Step no.:	3.3
Value Min	5.<u>0</u>

An interruption in power to the sensor, electrical faults or air in the sensor can cause measurements of extremely low conductivity to occur. A minimum value MIN of 0.1 up to 99.9% can be set. After a fixed delay of 60 seconds, the LCD displays the message: "Limit CM% MIN under valued."

Setting the alarm relay or malfunction relay is performed in steps 13 and 14.

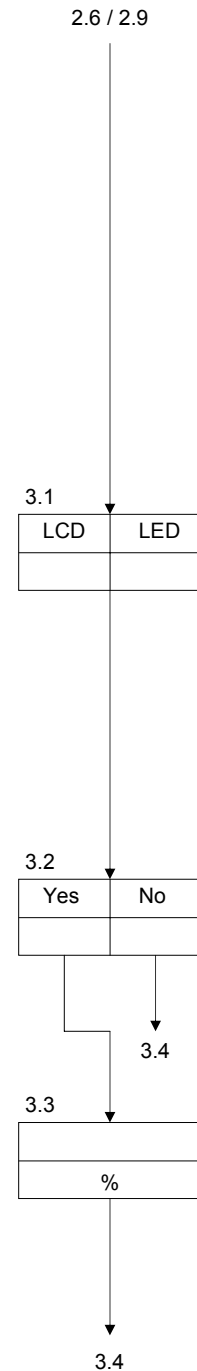

Step no.:	3.4
Limit Max	Y/<u>N</u>

This enables monitoring of relative conductivity values which are above a set maximum.

Step no.:	3.5
Value Max	50.<u>0</u>

Changes in the quality of the feed water for the unit can affect conductivity. A maximum value MAX can be set of 0.2 up to 99.9%

NOTE: This value must be greater than MIN.

Step no.:	3.6
Switch off	Y/<u>N</u>

This enables setting whether the unit should be shut down when a value in excess of the setpoint for MAX is recorded.

Step no.:	3.7
Delay	180<u>s</u>

If the MAX setpoint is exceeded, after a programmed delay of between 1 and 9999 seconds, the message "Limit CM1 % MAX exceeded" is displayed on the LCD and, if programmed, the unit is shut down.

Setting the alarm relay or malfunction relay is performed in steps 13 and 14

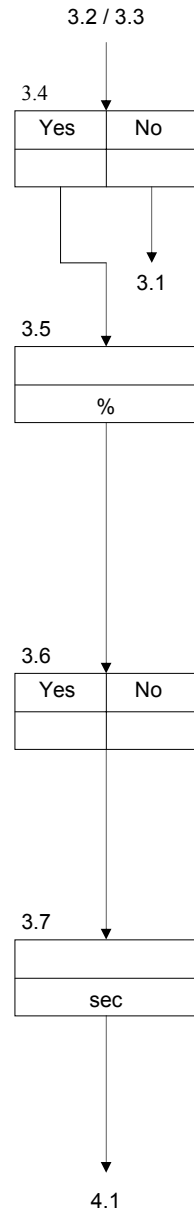

4. Temperature measurement

NOTE: If only the standard board is installed in the unit, no temperature measurement can be performed. To perform manual temperature compensation for conductivity, however, a temperature other than 25 °C within the range 0 to 99 °C can be entered in the program.

Step no.:	4.1
Temperature	2<u>5</u>°C

If the extended board with two conductivity meters and temperature measurement capability is installed, it is possible to program temperature to be displayed on the LCD.

Step no.:	4.2
Display	Y/<u>N</u>

NOTE: If CM1, CM2 or CM% are displayed on the same output device, each value is displayed for 2 seconds, in cycle.

Step no.:	4.3
Limit Temp.	Y/<u>N</u>

This enables monitoring of maximum water temperature.

Step no.:	4.4
Value Max	8<u>0</u>°C

For monitoring purposes you can here enter a threshold limit value between 1°C and 99°C.

Step no.:	4.5
Switch off	Y/<u>N</u>

This enables setting whether the unit should be shut down when the temperature has exceeded the maximum limit programmed in step 4.4. If the temperature is under the limit value then the installation will start automatically

1.6 / 1.8 / 3.4 / 3.7

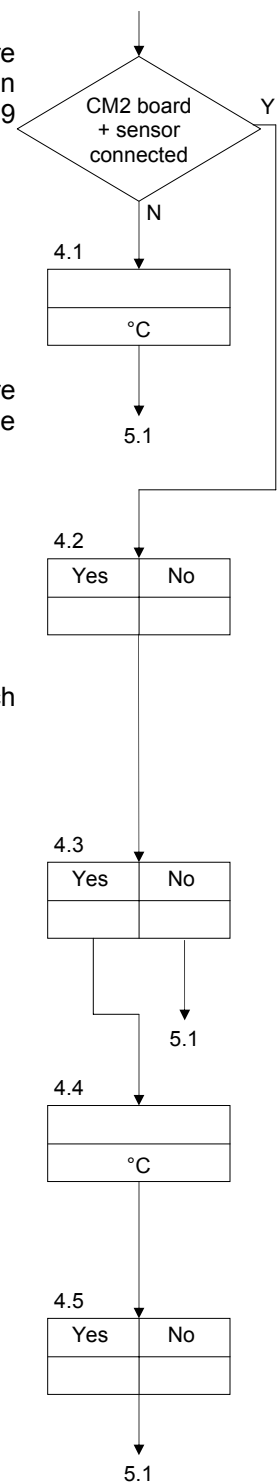

5. Conductivity – correction factor

Step no.:	5.1
Factor 1	1.00*

Conductivity measurement is based upon a temperature of 25 °C. At other temperatures the conductivity measurement must be adjusted by means of a manual correction factor, or if a temperature sensor is installed, an automatic correction factor.

Other spurious measurements caused, for example, by polarization, or by resistance or capacitance in the wiring, can also be compensated for by a correction factor - at least for a certain range.

A correction factor of 0.10 to 5.0 can be entered in this step for conductivity 1.

Determination of the correction factor for conductivity

Take a sample of water and measure conductivity with an accurate and calibrated conductivity meter: reference value.

Note the conductivity registered by the controller. Calculate the correction factor to be entered as follows :

$$\frac{\text{reference value}}{\text{measured value}} = \text{correction factor}$$

Step no.:	5.2
Factor 2	1.00*

A correction factor of 0.10 to 5.0 can be entered in this step for conductivity 2

6. Start up delay

Step no.:	6.1
Delay	15s

To prevent water hammer when production is started, in "PRODUCTION" mode, a delay is programmed before the h.p. pump is started. A delay can be programmed of between 1 and 999 seconds

Step no.:	6.2
WithConcValveY/N	<u>N</u>

Two starting programmes can be chosen for "PRODUCTION":

with concentrate discharge valve J/N: inlet valve opens - delay, h.p. pump starts. Step "PRODUCTION" starts.

with concentrate discharge valve J/N: concentrate discharge valve opens - delay - inlet valve opens - delay - h.p. pump starts - delay - concentrate discharge valve closes. Step "PRODUCTION" starts.

When programmed in step no. 6.1 a delay of 15 seconds, then the production step will have a total delay of 3 x 15 seconds.

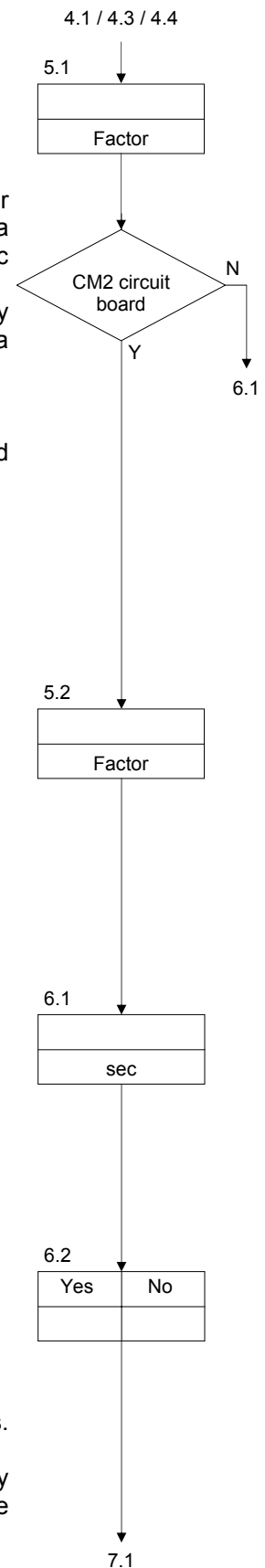

7. Concentrate flow monitoring

Schritt Nr: 7.0

CO RS

Select the desired input function for the 'CO' connection on the terminal strip.

CO = Cocentrate flow (see also page 23)

RS = Reset alarm output (see also page 23)

Step no.: 7.1

Delay1 60s

The delay for the concentrate flow monitoring switch can be programmed between 1 and 999 seconds.

Step no.: 7.2

Switch on 3*

The unit can be programmed to attempt restarting production a number of times, in the event that low concentrate flow is detected, before the unit is definitively stopped. It is then only possible to restart the unit manually by pressing the "ON" key.

A value between 0 and 9 can be entered here. The value 0 means that no definitive shutdown occurs and the unit is restarted automatically as soon as permeate can be accepted by the process and concentrate is flowing. The value 1 shuts the unit down definitively at the first detection of low concentrate flow. With the values 2 to 9, the unit attempts 1 to 8 times to start production, in spite of the signal that low concentrate flow has been detected.

Step no.: 7.3

Delay2 2m

If a value between 2 and 9 is set for restarting production, the delay until restart must be programmed. The delay can be between 1 and 99 minutes.

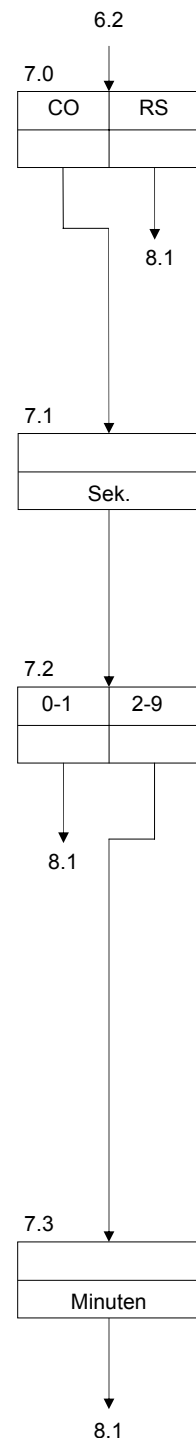

8. Rinse before Standby

Step no.: 8.1
Rinse-Standby Y/N

Before the change over from the production mode to the Standby-mode and after turn on the controller the membrane can be rinsed

Step no.: 8.2
Rinsetime1 600s

This enables a rinse cycle of 1 to 9999 seconds to be programmed.

Step no.: 8.3
PU | **IV** | **CV** | **PV** |

You can program, whether the rinsing process takes place with or without the pump and whether the cut-off valves are open or closed:

PU = with pump	PU - = without pump
IV = input cut-off valve open	IV - = input cut-off valve closed
CV = concentrate cut-off valve open	CV - = concentrate cut-off valve closed
PV = permeate cut-off valve open	PV - = permeate cut-off valve closed

Step no.: 8.4
Conc.Valve NoNc

This sets the kind of concentrate valve you are using: "normally open" (No) or "normally closed" (Nc)

Attention: The steps 8.4 and 9.5 are identical.

Tip: Using very saline water with a closed inlet valve, herewith you have the possibility to rinse the module by the dosing pump (DO) connection.
Programming step 10.1=Yes, 10.2=No, 10.3=Yes, 10.4=No and 10.5=0

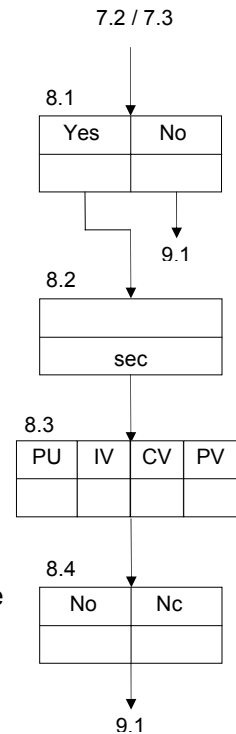

9. "Interval" Rinse

Step no.: 9.1
Interval Y/N

The lifetime of the membrane will be extended if the module is regularly rinsed by the concentrate piping.

Step no.: 9.2
Distance 24h

This sets how long between the previous step or rinse and the concentrate rinse. A delay of 1 to 999 hours can be programmed.

Step no.: 9.3
Rinsetime2 300s

This enables a rinse cycle of 1 to 9999 seconds to be programmed.

Step no.: 9.4
PU | **IV** | **CV** | **PV** |

You can program, whether the rinsing process takes place with or without the pump and whether the cut-off valves are open or closed:

PU = with pump	PU - = without pump
IV = input cut-off valve open	IV - = input cut-off valve closed
CV = concentrate cut-off valve open	CV - = concentrate cut-off valve closed
PV = permeate cut-off valve open	PV - = permeate cut-off valve closed

Step no.: 9.5
Conc.Valve NoNc

This sets the kind of concentrate valve you are using: "normally open" (No) or "normally closed" (Nc)

Attention: The steps 8.4 and 9.5 are identical. If you have programmed step no. 8.1 = Yes, this program step will not be displayed.

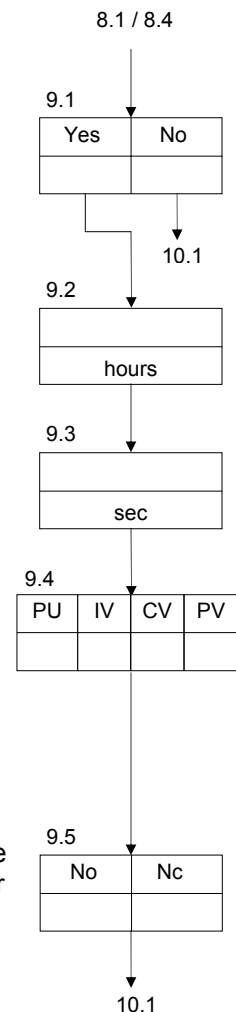

10. Dosing pump

Step no.:	10.1
Dosing	Y/<u>N</u>

Dosing of chemicals can be done during "PRODUCTION", "RINSE" and/or "MAINTENANCE."

If step 10.1 is programmed at No this output will be switched parallel to the output PU.

Step no.:	10.2
Dos.Product.	Y/<u>N</u>

Dosing YES/NO during "PRODUCTION" mode

Step no.:	10.3
Dos.Rinse	Y/<u>N</u>

Dosing YES/NO during "RINSE" mode.

Step no.:	10.4
Dos.Mainten.	Y/<u>N</u>

Dosing YES/NO during "MAINTENANCE" mode.

Step no.:	10.5
Dosingtime	12<u>0</u>s

The duration of dosing is set for each step. It is terminated, though, if the unit is switched/switches to another step. A value of 0 to 65,000 seconds may be set.

NOTE: If the value 0 is set, the dosing pump is on for the entire duration of the step.

Step no.:	10.6
Delay	<u>5</u>s

The dosing pump can be started with a delay of between 0 and 999 seconds

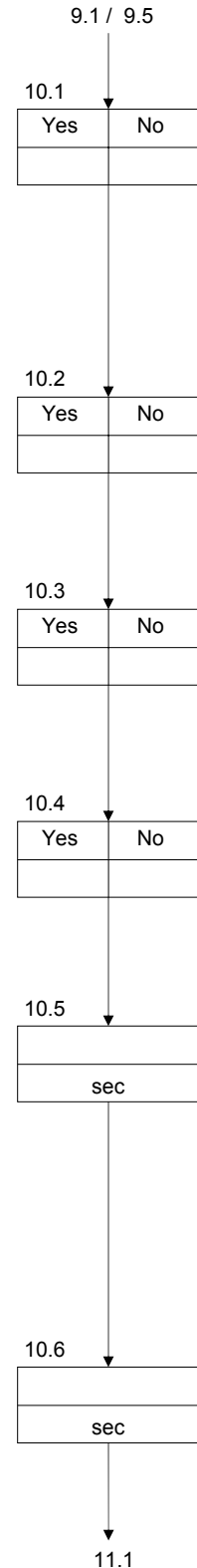

11. Level control

Step no.:	11.1
Level switch	<u>2</u>

Filling of the storage tank can be controlled by means of the full level switch. In this manner, the unit is put into operation as soon as the water level drops below the maximum level. The empty level switch serves as a minimum level protection. Advantage: A maximum amount is always available.

Select: **Level switch = 1.**

As an alternative, filling can be regulated by two level switches. In this set-up, the unit is started when the "empty" level gauge is tripped and shut off when the "full" level gauge is tripped.

Advantage: The unit is started and stopped less frequently.

Select: **Level switch = 2.**

If no level switches for a supply tank are connected, then you can only switch the installation on and off manually.

The inputs "FULL" and "EMPTY", however, appear in the display upon activation and are able to activate with the message and fault relay.

Select: **Level switch = 0.**

ATTENTION : If the production is stopped by hand (OFF key) then the production will only start after pressing the ON key.

12. Low pressure

Step no.:	12.1
Delay1	<u>10</u> s

The delay for the low pressure signal can be programmed between 1 and 999 seconds.

Step no.:	12.2
Switch on	<u>3</u> *

The unit can be programmed to attempt restarting production a number of times, in the event that low pressure is detected, before the unit is definitively stopped. It is then only possible to restart the unit manually by pressing the "ON" key.

A value between 0 and 9 can be entered here. The value 0 means that no definitive shutdown occurs and the unit is restarted automatically as soon as pressure rises above the minimum level. The value 1 shuts the unit down definitively at the first detection of low pressure. With the values 2 to 9, the unit attempts 1 to 8 times to start production, in spite of the low pressure signal.

Step no.:	12.3
Delay2	<u>15</u> m

If a value between 2 and 9 is set for restarting production, the delay until restart must be programmed. The delay can be between 1 and 99 minutes

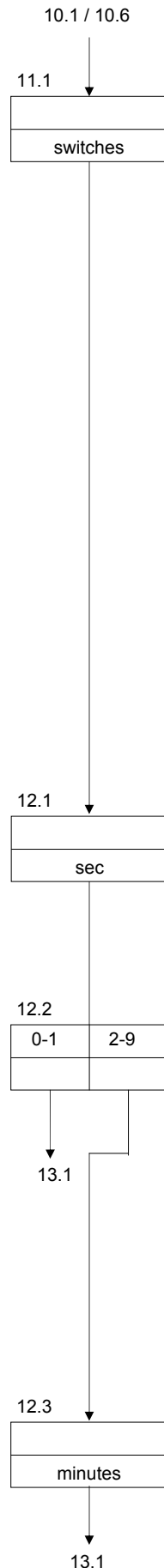

13. Alarm relay

The occurrence of certain situations can be signalled by means of the alarm and/or malfunction relay. In step 13 of the basic program, it is possible to set which situations activate the alarm relay.

Step no.:	13.1
CM1 Min	<u>Y</u>/N

Conductivity CM 1 MIN under the minimum value.

Step no.:	13.2
CM1 Max	<u>Y</u>/N

Conductivity CM 1 MAX above the maximum value.

Step no.:	13.3
Stop	<u>Y</u>/N

The "STOP" input has been activated.

Step no.:	13.4
Empty	<u>Y</u>/N

The "EMPTY" input has been activated.

Step no.:	13.5
Full	<u>Y</u>/N

The "FULL" input has been activated.

Step no.:	13.6
Overpressure	<u>Y</u>/N

The "OVERPRESSURE" input has been activated.

Step no.:	13.7
Low pressure	<u>Y</u>/N

The "LOW PRESSURE" input has been activated.

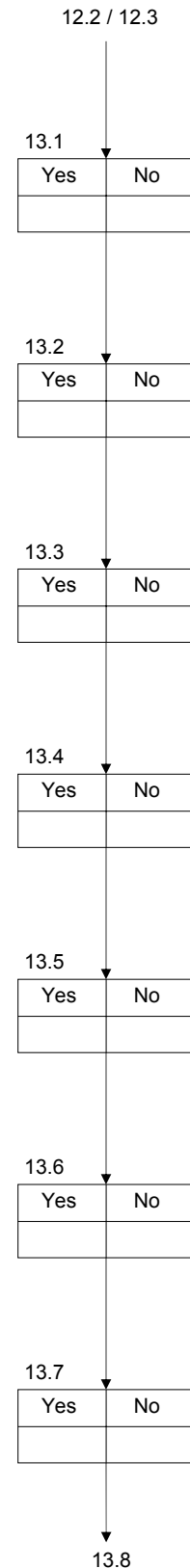

Step no.: 13.8
Concentrate Y/N

The "CONCENTRATE" input has been activated.

Step no.: 13.9
Motorprotect Y/N

The "MOTOR SAFEGUARD" input has been activated.

Step no.: 13.10
Supplyfail.S/Y/N

The "POWER FAILURE" situation has been activated.

- S** = Installation remains in the "STANDBY STOP" position until the "ON" key is pressed, message relay active. (See installation instructions / putting into operation page 46)
- Y** = Message relay active
- N** = Message relay not active

Step no.: 13.11
Maintenance Y/N

The "MAINTENANCE INTERVAL REQUESTED" input has been activated.

Step no.: 13.12
CM2 Min */P/N

Conductivity CM 2 MIN under the minimum value.

- *** = Always controlling of the conductivity minimum value
- P** = Controlling of the conductivity minimum value only during the production-mode
- N** = No controlling and activating of the alarm relay

Step no.: 13.13
CM2 Max */P/N

Conductivity CM 2 MAX above the maximum value.

- *** = Always controlling of the conductivity minimum value
- P** = Controlling of the conductivity minimum value only during the production-mode
- N** = No controlling and activating of the alarm relay

Step no.: 13.14
CM% Min Y/N

Percentage relative conductivity CM% MIN under the minimum value.

Step no.: 13.15
CM% Max Y/N

Percentage relative conductivity CM% MAX above the maximum value

Step no.: 13.16
LimitTemp. Y/N

Temperature above the maximum value.

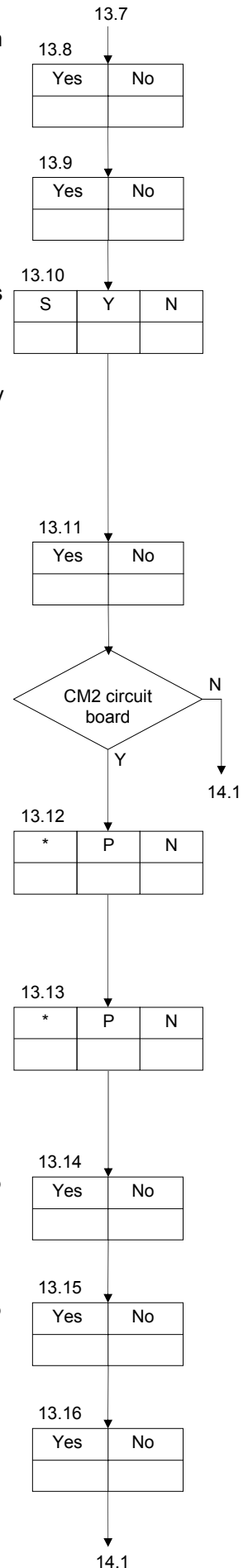

14. Malfunction relay

The occurrence of certain situations can be signalled by means of the alarm and/or malfunction relay. In step 14 of the basic program, it is possible to set which situations activate the malfunction relay.

Step no.:	14.1
CM1 Min	<u>Y</u>/N

Conductivity CM 1 MIN under the minimum value.

Step no.:	14.2
CM1 Max	<u>Y</u>/N

Conductivity CM 1 MAX above the maximum value.

Step no.:	14.3
Stop	<u>Y</u>/N

The "STOP" input has been activated.

Step no.:	14.4
Empty	<u>Y</u>/N

The "EMPTY" input has been activated.

Step no.:	14.5
Full	<u>Y</u>/N

The "FULL" input has been activated.

Step no.:	14.6
Overpressure	<u>Y</u>/N

The "OVERPRESSURE" input has been activated.

Step no.:	14.7
Low pressure	<u>Y</u>/N

The "LOW PRESSURE" input has been activated.

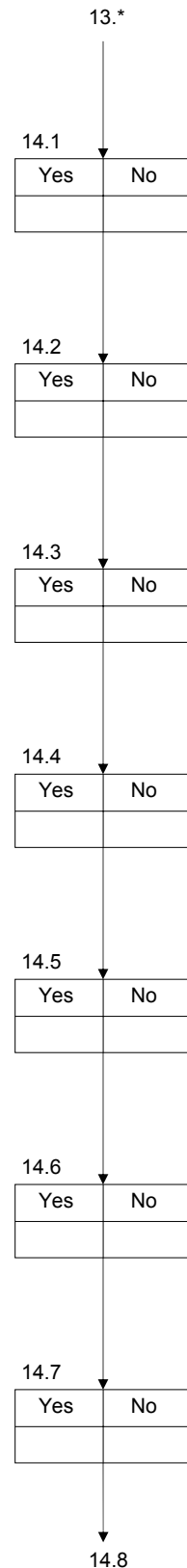

Step no.: 14.8
Concentrate Y/N

The "CONCENTRATE" input has been activated.

Step no.: 14.9
Motorprotect Y/N

The "MOTOR SAFEGUARD" input has been activated.

Step no.: 14.10
Supplyfail.S/Y/N

The "POWER FAILURE" situation has been activated.

- S** = Installation remains in the "STANDBY STOP" position until the "ON" key is pressed, message relay active. (See installation instructions / putting into operation page 46)
- Y** = Message relay active
- N** = Message relay not active

Step no.: 14.11
Maintenance Y/N

The "MAINTENANCE INTERVAL REQUESTED" input has been activated.

Step no.: 14.12
CM2 Min */P/N

Conductivity CM 2 MIN under the minimum value.

- *** = Always controlling of the conductivity minimum value
- P** = Controlling of the conductivity minimum value only during the production-mode
- N** = No controlling and activating of the alarm relay

Step no.: 14.13
CM2 Max */P/N

Conductivity CM 2 MAX above the maximum value.

- *** = Always controlling of the conductivity minimum value
- P** = Controlling of the conductivity minimum value only during the production-mode
- N** = No controlling and activating of the alarm relay

Step no.: 14.14
CM% Min Y/N

Percentage relative conductivity CM% MIN under the minimum value.

Step no.: 14.15
CM% Max Y/N

Percentage relative conductivity CM% MAX above the maximum value

Step no.: 14.16
LimitTemp. Y/N

Temperature above the maximum value.

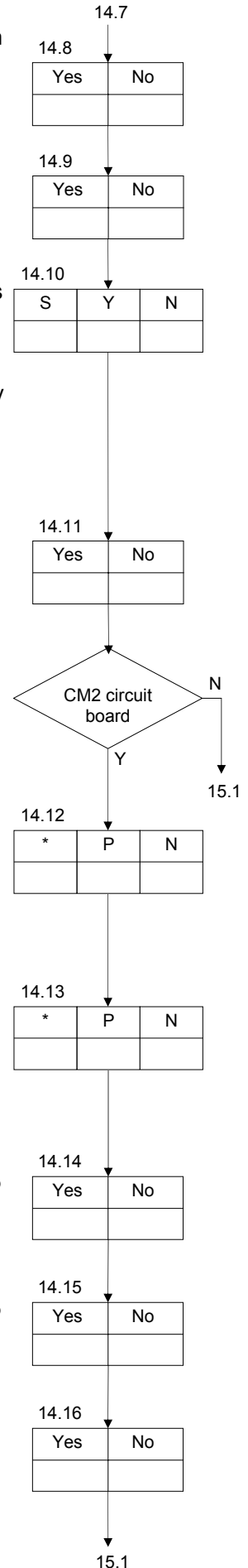

15. Recorder output

NOTE: The following steps can only be selected when the controller is fitted with an interface board for a recorder.

Step no.:	15.1
0-20 mA	<u>4</u>-20 mA

The output current can be set to a range of either 0-20 mA or 4-20 mA. In case of 4-20 mA the current will be raised by 4 mA.

Controller with one conductivity meter.

Both recorder outputs have the same conductivity value.

Controller with two conductivity meters.

This performance has available 4 analogous values: conductivity value 1, conductivity value 2, relative conductivity and the temperature value. (if the probe is connected)

The following steps allow you to programme the values of the outputs 1 and 2. Use the key "#" to switch the number 1 respectively 2 on or off.

If one output has more values, each value will be shown in steps of 2 seconds.

Advice: use a "dot"-recorder instead of a "line"-recorder.

To optimise the display of the outputs the following steps allow you to programme a variable division of the current
0(4) - 20mA.

Attention! In case of 4 - 20 mA, to convert to the corresponding conductivity value, you have to deduct 4 mA from the current value.

For example: you have programmed 0 - 20 mA 0 - 20 μ S/cm, the maximum of 16 mA i.e. 16 μ S/cm can be displayed.

Step no.:	15.2
MeasuremCM1	1_2 -

You can select on which output the value of Conductivity meter 1 must be displayed.

Step no.:	15.3
Range	0 - <u>20</u>

The range of conductivity can be related to the current of 0(4) - 20 mA.

For example 0 - 20 mA 0 - 200 μ S/cm.

One step of 1 mA corresponds with one step of 10 μ S/cm.

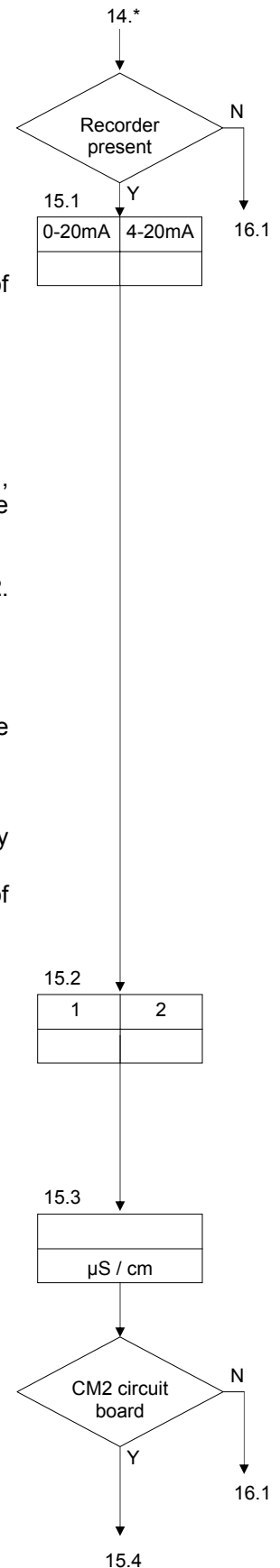

Attention! The following steps are only available for controllers with two conductivity meters.

Step no.: 15.4
MeasuremCM2 1-2-

You can select on which output the value of Conductivity meter 2 must be displayed.

Step no.: 15.5
Range 0- 200

The range of conductivity can be related to the current of 0(4) - 20 mA.

For example 0 - 20 mA 0 - 2,000 $\mu\text{S}/\text{cm}$.

One step of 1 mA corresponds with one step of 100 $\mu\text{S}/\text{cm}$.

Step no.: 15.6
MeasuremCM% 1-2-

You can select on which output the value of the relative conductivity must be displayed.

Step no.: 15.7
Range 0- 100

The range of relative conductivity can be related to the current of 0(4) - 20 mA.

For example 0 - 20 mA 0 - 40 %.

One step of 1 mA corresponds with one step of 2 %.

A value can be programmed between 0 and 100 %.

Step no.: 15.8
Measurem°C 1-2-

You can select on which output the value of Conductivity meter 2 must be displayed.

Step no.: 15.9
Range 0- 100

The range of temperature (0 - 100 °C) can be related to the current of 0(4) - 20 mA.

For example 0 - 20 mA 0 - 50 °C.

One step of 1 mA corresponds with one step of 2.5 °C.

A value can be programmed between 0 and 100 °C.

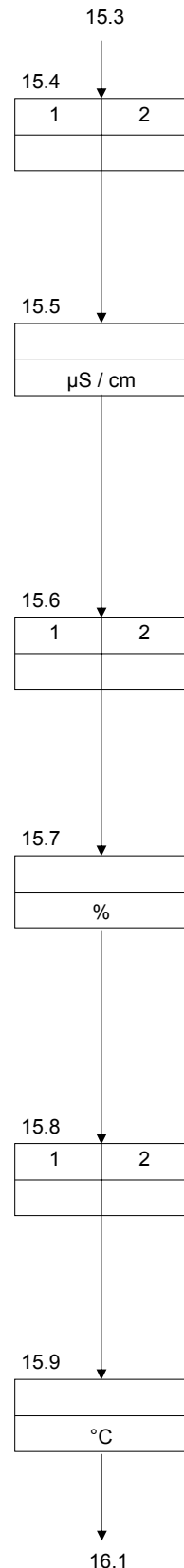

Step no.:	16.6
Codenumber	Y/ <u>N</u>

To prevent unauthorized personnel from entering "MAINTENANCE" mode or changing the values in the program, it is possible to assign a code number.

ATTENTION: Record the code number in the documentation. After assignment of a code number it is no longer possible to invoke this step and change the code number.

Step no.:	16.7
Codenumber	<u>0</u>

In this step, the code number is entered.

17. Permeate valve

Step no.:	17.1
Permeate valve	<u>0</u>

Dependant upon the way the valve is fitted and connected to the "PV" terminals, it can function either, as a purge valve, or, as a permeate valve.

The valve operation, either normally open or normally closed, in the "Standby" mode is determined in this step of the programming.

"1" = purge valve opened / permeate valve closed

"0" = purge valve closed / permeate valve opened

18. Input "Stop"

Step no.:	18.1
Handstart	Y/ <u>N</u>

If "Stop Hand start" is set to "J" for yes, then after activating the stop input at terminals 23 and 24, "Signal start by hand" appears in the LCD display. The installation must be restarted again by pressing the "ON" key .

If " Stop Hand start " is set to "N" for no, then after activating the stop input, "Signal STOP" appears in the LCD display.

The installation continues its normal procedure when the stop input has been deactivated.

See also input functions: STOP on page 22

Step no.:	18.2
Input Stop	<u>0</u>

Choose the activation option for the STOP input.

0 = Function is activated when the contact is opened.

1 = Function is activated when the contact is closed.

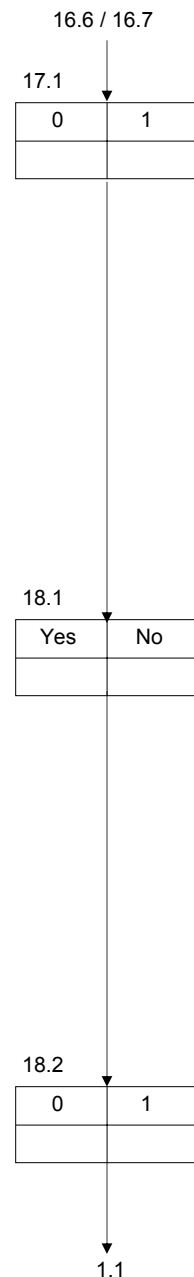
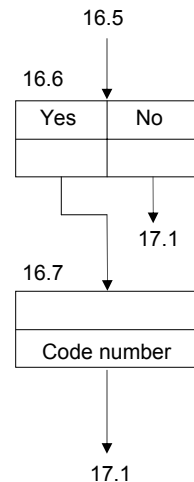



Central Monitoring

For monitoring of the installation from a central monitoring station, ungrounded (single-edged) relay contacts are available. Additional ungrounded relay contacts can be provided by external relays.

On the relay outputs AN (Alarm) and MF (Malfunction), the following signals can be assigned:

1. Conductivity 1 MIN
2. Conductivity 1 MAX
3. Reverse osmosis unit stop
4. Storage tank full
5. Storage tank empty
6. Overpressure
7. Low pressure
8. Concentrate flow low
9. Motor safeguard switch
10. Power failure
11. Maintenance requested
12. Conductivity 2 MIN
13. Conductivity 2 MAX
14. Relative Conductivity 1 MIN
15. Relative Conductivity 1 MAX
16. Temperature above maximum

On each relay, more than one signal can be assigned.

If the DO output (dosing) is not used for dosing, a signal can be generated during the steps "PRODUCTION", "RINSE" or "MAINTENANCE." The duration of the signal is programmable.

NOTE: If the ungrounded (single-edged) contacts are required to switch valves, alarm bells, lamps or other devices simultaneously, extra external relays must be used.

The following ungrounded (single-edged) contacts can be obtained using external relays:

- PU = pump (high pressure pump is on)
- IV = inlet valve (unit is in operation)
- CV = concentrate valve ("RINSE" mode)
- PV = permeate valve (quality of desalinated water is poor)



Installation and start up instructions

- ✓ Install unit at eye-level and position suitable for operation.
- ✓ Do not mount under leaky piping. If necessary, use protective shielding.
- ✓ Slide (internal) panel-mounted model into panel opening (186 x 138) and fasten using clamps supplied.
- ✓ Connect to mains power. Ensure that all local regulations as well as instructions and guidelines of utility companies are obeyed.
- ✓ Pay particular attention to proper earth connection.
- ✓ All low-voltage connections (contacts 23-48, i.e., connections ST, FU, EM, EP, LP, CO, PS, CC1, CC2, TC and RC) are separated from main power supply.
- ✓ Note: The panel-mounted unit is supplied without a main power switch. Provide for an "Emergency Off" facility, e.g., in the switch box.
- ✓ Note: The front panel is connected to ground with a plug. This connection must not be broken during operation.
- ✓ Turn the controller on and using this manual and the technical specifications of the unit supplier program the controller.
- ✓ Start the unit in accordance with the supplier's instructions. Measure conductivity of the permeate using a conductivity meter, compare with values displayed in the LED and correct, if necessary.
- ✓ NOTE: Keep front cover closed during operation at all times to prevent water damage.

- ✓ **ATTENTION:** Some external relays, magnetic switches, magnetic valves, etc. can cause undesirable interference pulses when switching off. For this reason it is recommended to provide the components mentioned, in advance, with a "RC-network". Inquire at the supplier of the components mentioned for the correct type of RC-network.

"STANDBY STOP" display when put into operation:



The high pressure pump and the cut-off valves are not driven in this position.

Exceptions: when altering the program steps 8.4, 9.5 and 17.1. The following actions can be carried out:

1. Programming the basic values;
2. Calling the info data;
3. Switching the "MAINTENANCE" step on and off;
4. Starting production;
5. Stopping production or starting a rinse;
6. Deactivating the message or fault relay.

Once the "ON" key for production start or the "OFF" key for production stop has been pushed, the "STANDBY STOP" function is cancelled and then when switching on the mains power switch another time, a normal start follows, which generally starts with rinsing.

Activating the "STANDBY STOP" function.

The "STANDBY STOP" function can be re-activated:

1. Hold down the "ON" key when switching on the main switch.
2. After loading new software
3. After each power failure, if the cursor is set to "S" for stop in program step 13.10 or 14.10 (Application: depending upon the operational management the installation may not automatically come back into operation following a power failure).

Production

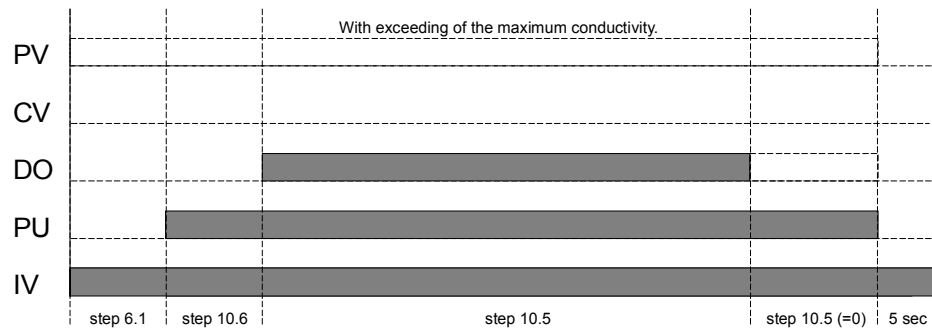

Example: Starting up without concentrate valve (step 6.2 = No).

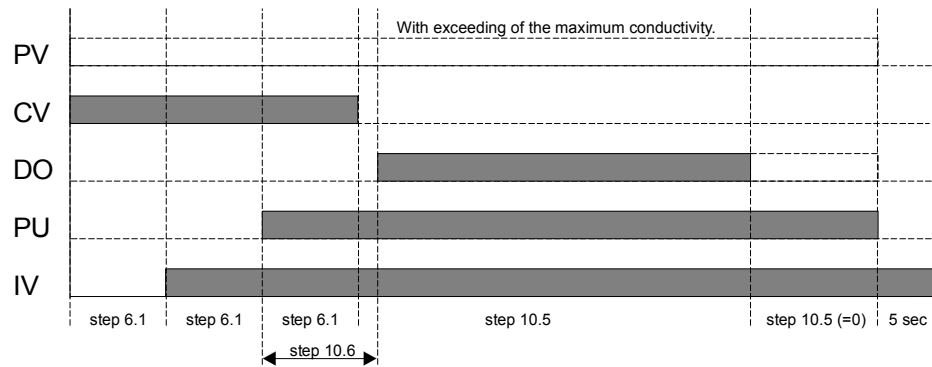

Example: Starting up with concentrate valve (step 6.2 = Yes).

Rinse

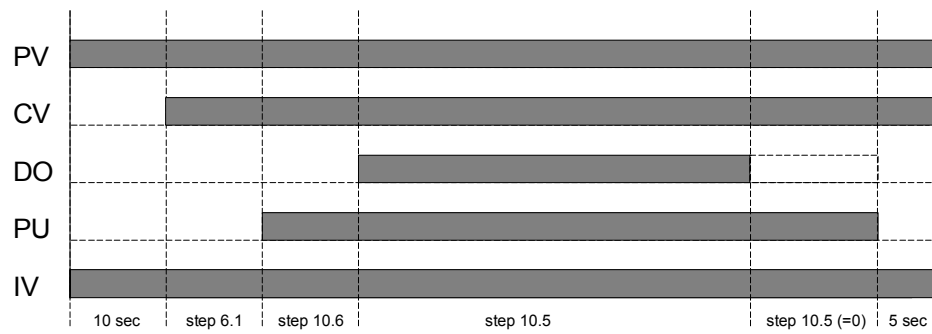

Example: step 8.3 : PU | IV | CV | PV |

Maintenance

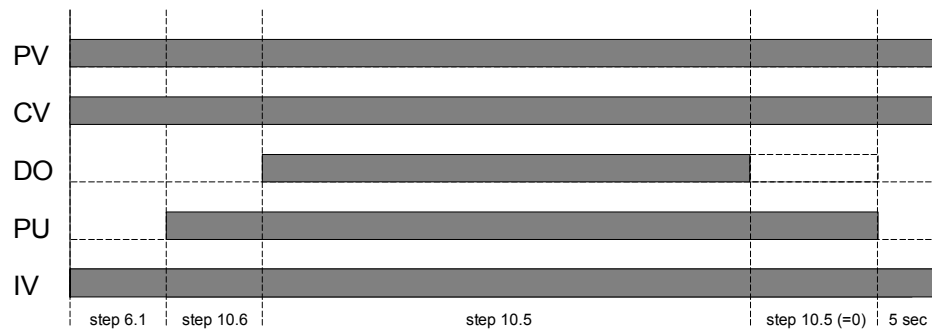

Example: step 16.5 : PU | IV | CV | PV |

Connection terminals OS3050 / OS3051

OS3050 - 24 V :
Only earth terminal 49
no control lamp in the main switch

OS3051:
Only earth terminal 49

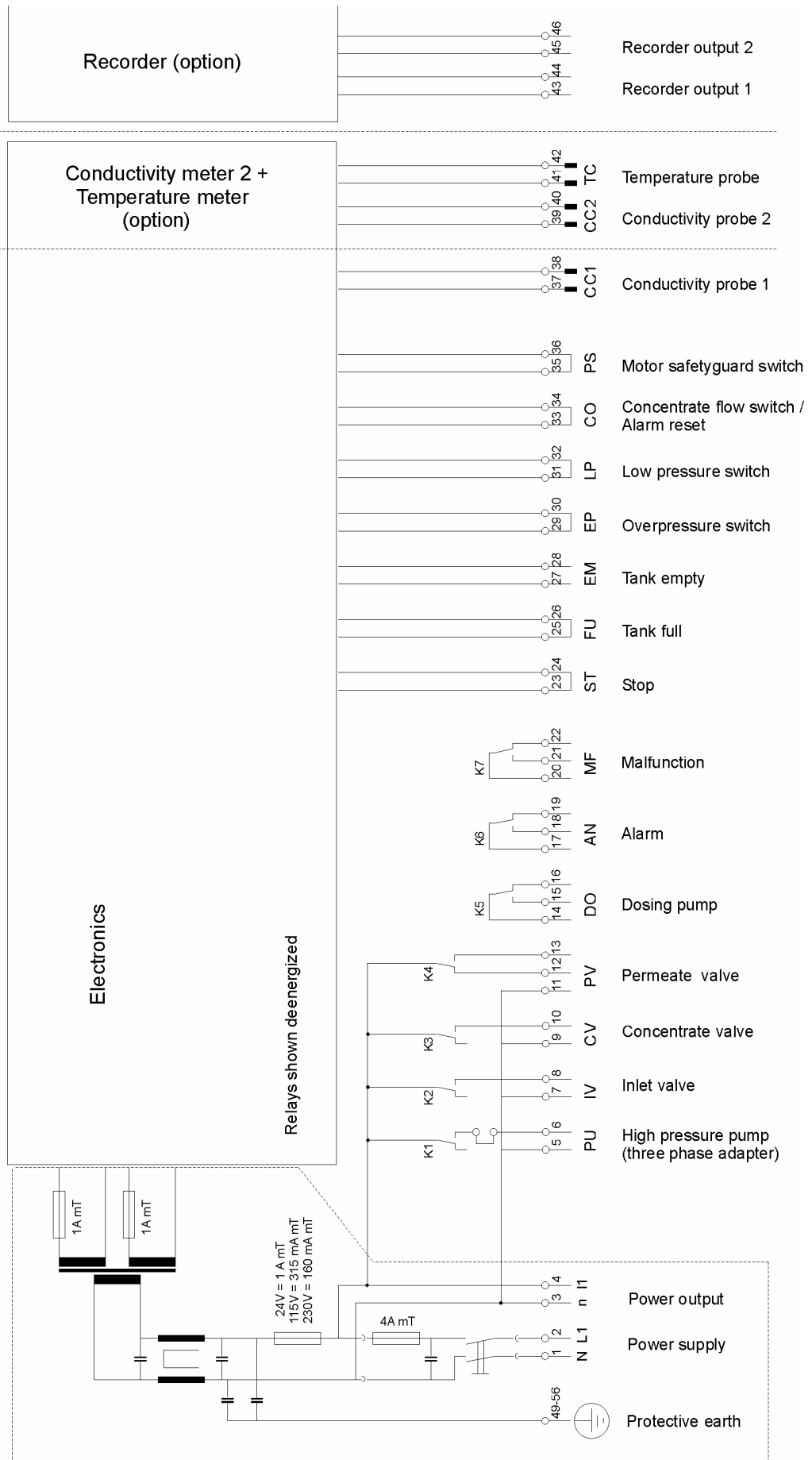



Technical data



Mains connection : 24V $\pm 10\%$ 50-60 Hz fuse 4A mT
 115V $\pm 10\%$ 50-60 Hz fuse 4A mT
 230V $\pm 10\%$ 50-60 Hz fuse 4A mT

Power consumption : 11VA

Voltage-carrying outputs : Output voltage is equal to supply voltage.
 Max. total load capacity 4A

Potential-free outputs : Max. load capacity 250V, 4A

Inputs : Load capacity 9V, 8 mA

Protection class : IP65 (OS3050)
 IP42 (OS3051)

Environmental temperature : 0 – 50 °C

Weight : Approx. 2.8 kg

Dimensions OS3050: W x H x D = 263 x 216 x 142 mm

Dimensions OS3051: DIN 43 700

Front : 192 mm x 144 mm
Overall depth : 122 mm
Panel opening : 186 mm x 138 mm

Particulars : Device is protected against zero voltage



Declaration of conformity

Declaration of conformity of the product with the essential requirement of the EMC directive 89 / 336 / EEC.

Product description

Product name : Controller for reverse osmosis systems
Product type : OS3050, OS3051
Manufacturer : EWS Equipment for Water treatment Systems International B.V.

Product environment

This product is intended for use in residential en light industrial environments.

Emission standard : EN 55022, class B
Immunity standard : EN 50082-1

Report

Report number : EWS / EMC9603

This declaration was issued by :

Date : 18-06-1999

Name : D.H. Naeber

Signature :



FIVE-YEAR CONTROLLER LIMITED WARRANTY

LIMITED WARRANTY

EWS International (hereafter EWS) warrants her products free from defects in material and workmanship under the following terms.

In this warranty, "Products" shall be taken to mean all devices that are supplied pursuant to the contract with exception of software.

VALIDITY OF THE WARRANTY

Labour and parts are warranted for five years from the date of the first customer purchase. This warranty is only valid for the first purchase customer.

Notwithstanding the warranty period of five years as mentioned above - while upholding the remaining provisions – a warranty period of three months applies to the supply of software.

COVER OF THE WARRANTY

Subject to the exceptions as laid down below, this warranty covers all defects in material or workmanship in the EWS products. The following are not covered by the warranty:

- 1) Any product or part not manufactured nor distributed by EWS. EWS will pass on warranty given by the actual manufacturer of products or parts that EWS uses in the product.
- 2) Any product, on which the serial number has been defaced, modified or removed.
- 3) Damage, deterioration or malfunction resulting from:
 - a) Accident, misuse, neglect, fire, water, lightning or other acts of nature.
 - b) Product modification or failure to follow instructions supplied by the products.
 - c) Repair or attempted repair by anyone not authorized by EWS.
 - d) Any shipment of the product (claims must be presented to the carrier)
 - e) Removal or installation of the product
 - f) Any other cause, which does not relate to a product defect.
 - g) Cartons, equipment enclosures, cables or accessories uses in conjunction with the product.

FINANCIAL CONSEQUENCES

EWS will only pay for labour and material expenses for covered items, proceed from repairs and updates done by EWS at the EWS location. EWS will not pay for the following:

- 1) Removal or installations charges at customers and/or end user location.
- 2) Costs for initial technical adjustments (set-up), including adjustment of user controls or programming.
- 3) Shipping charges proceed from returning goods by the customer. (Shipping charges for returning goods to the customer are for the account of EWS).

All the costs which exceed the obligations of EWS under this Warranty, such as, but not limited to, travel and accommodation costs and costs for assembly and dismantling are for the account and risk of the customer.

WARRANTY SERVICE

In order to retain the right to have a defect remedied under this warranty, the customer is obliged to:

- 1) Submit complaints about immediately obvious errors related to the products delivered, in writing within eight days of the delivery of the products and submit complaints about shortcomings relating to the products delivered, which are not visible, within eight days of their being discovered.
- 2) Return defected products for account and risk of the customer. Costs for this shipment will not be reimbursed by EWS. The products may only be returned following express, written permission from EWS. Returning the products does not affect the obligation to pay the invoiced amounts.



- 3) Present the original dated invoice (or a copy) as proof of warranty coverage, which must be included in any [of the] return shipment of the product. Please include also in any mailing a contact name, company, address and a description of the problem(s).

LIMITATION OF IMPLIED WARRANTIES

Except where such disclaimers and exclusions are specifically prohibited by applicable law, the foregoing sets forth the only warranty applicable to the product, and such warranty is given expressly and in lieu of all other warranties, express or implied, or merchantability and fitness for a particular purpose and all such implied warranties which exceed or differ from the warranty set forth herein are hereby disclaimed by EWS.

EXCLUSION OF DAMAGES

EWS' liability for any defective products is limited to the repair or replacement of the product at our option. Except where such limitations and exclusions are specifically prohibited by applicable law EWS shall not be liable for:

- 1) Damage to other property caused by defects in the EWS product, damages based upon inconvenience, loss of use of the product, loss of time, commercial loss or:
- 2) Any damages, whether incidental, [consequential or otherwise] special, indirect or consequential damages, injury to persons or property, or any other loss.

Under no circumstances whatsoever shall EWS be obliged to provide compensation beyond the direct damage incurred by customer up to an amount not exceeding the payment receivable from the insurer of EWS in connection with the damage.

APPLICABLE LAW AND DISPUTES

- 1) Dutch law shall govern all offers made by EWS and all agreements concluded between EWS and customer. This warranty explicitly excludes application of the Vienna Sales Convention (CISG).
- 2) All disputes which may arise between the parties shall be dealt with exclusively by the competent court of law in the Netherlands under whose jurisdiction EWS falls. However, EWS reserves the right to submit any disputes to the competent court in the customer's location.