ES 2070 SV

Electronic controller for water softening units



Instruction Manual

Software version 1.01

CONTENTS

System Description.....	1
Illustration.....	2
Status and Regeneration	3
Messages.....	3
LED - display.....	3
LED - control lamps.....	3
LCD - display.....	3
Service status.....	3
Regeneration status.....	4
Changing and indication of program values.....	5
Hardness of the water supply.....	5
Current Time.....	6
Information DISPLAYS.....	6
Software version.....	6
Flush period.	6
Regeneration time.....	6
Regeneration restrictions.....	6
Additional programs.....	7
Unit capacity.....	8
Treated water produced.....	8
Inputs.	8
Outputs.....	9
Service - Telephone number.....	9
Maintenance.....	9
Alarms / warnings.....	10
Programmed capacity exceeded.....	10
Electrical supply failure.....	11
Refill chemical tank.....	11
Await regeneration.....	12
Pre contact (regeneration pre initiation warning)	12
Minimum inter regeneration time limit.....	13
Message: Maintenance.....	13
Manual regeneration initiation.....	14
Remote control.....	15
"water meter" Signal input.....	15
"Stop service" Signal input	15
"Chemicals low" Signal input.....	15
"wait " Signal input.....	16
"start" Signal input.....	16

Special functions.....	17
Duty changeover without regeneration.....	17
Regeneration of the standby unit.....	17
Regeneration stop.....	17
Fast program facility.....	18
Flush ON/OFF.....	18
Regeneration without counter reset.....	18
Setting and changing of initial values.....	19
1. Installation	20
2. Pre service regeneration.....	20
3. Prohibited regeneration period.....	21
Start on real time clock.....	22
4. Time controlled regeneration.....	23
5. Minimum time between regeneration's.....	24
6. Water meter.....	25
7. Incoming water supply hardness.....	26
8. Exchange capacity.....	27
9. Pre regeneration signalling.....	28
10. Number of valve switching pulses.....	28
11. Electrical control.....	29
13. Regeneration times.....	30
14. Programmable outputs.....	31
15. Additional program 1.....	32
16. Additional program 2.....	33
17. Additional program 3.....	33
18. Flushing	34
19. Flow pulse	34
20. Alarm output	34
21. Warning output	35
22. "Wait" input	35
23. "Start" input.....	36
24. Maintenance	36
Wiring diagram.....	37
Technical specifications.....	38
Declaration of conformity.....	39



System Description

The **ES 2070 SV** controller is designed for the monitoring and control of simplex (single exchange column), duplex (twin exchange columns) water softener installations.

Whilst a simplex installation can not provide softened water to service when the exchange column is in regeneration, a duplex installation is capable of providing treated water from one columns whilst the other is being regenerated. Duplex plants can be operated either in duty/standby mode (one unit in service, the other either in regeneration or waiting to be called into service), or in parallel mode (two units in service except when one is regenerating). The regeneration of an exchange column is effected either by one central control valve or by means of a pilot system controlling individual valves.

Regeneration is usually initiated after a measured volume of water has passed through the plant, this volume is automatically calculated when the exchange capacity and the feed water hardness are programmed into the controller. Alternatively the regeneration cycle may also be initiated either, after a predetermined time period, or, by the operation of an external contact e.g. hardness monitoring equipment, or, push button, or, based on the real time clock. Because, particularly with simplex plants, there can be periods of the day when regeneration would be undesirable, e.g. periods of high demand, the control can be programmed so that regeneration cannot take place between certain times. When this postponed regeneration facility is in use, any initiation signal is stored and a display indicates the earliest time at which the already initiated regeneration cycle may commence.

An external contact may be used to:

- a) inhibit or abort a regeneration cycle
- b) open or close the service valve.

In order to prevent microbiological degradation of the unit due to prolonged periods of non operation, the stand-by unit of a duplex water softener installation can be regenerated immediately prior to being put into service.

A minimum time interval between successive regeneration cycles may be set, thus allowing brine systems to recover between regeneration's, if necessary.

Six volt free relay contacts are available for control of valves, pumps, lamps, etc. or can be used for remote monitoring. All these outputs are programmable for the following functions :

1. Three additional program relays :
Available before, during or after part of the regeneration cycle.
2. Flush relay :
Can be used to open a dump valve flushing the plant to drain each time a pre-set volume of treated water has been produced.
3. Transport pump relay :
Allows control of a valve or pump during the regeneration or service.
4. Regeneration relay:
Contact available during the regeneration cycle.
5. Flow pulse relay :
repeats the contact of the water meter for remote monitoring of water use.
6. Warning relay:
Programmable warning contact.
7. Alarm relay:
Programmable fault contact
8. Valve relay:
Programmable output for single valve filter.



Illustration

Wall-mounted type ES2070 SV

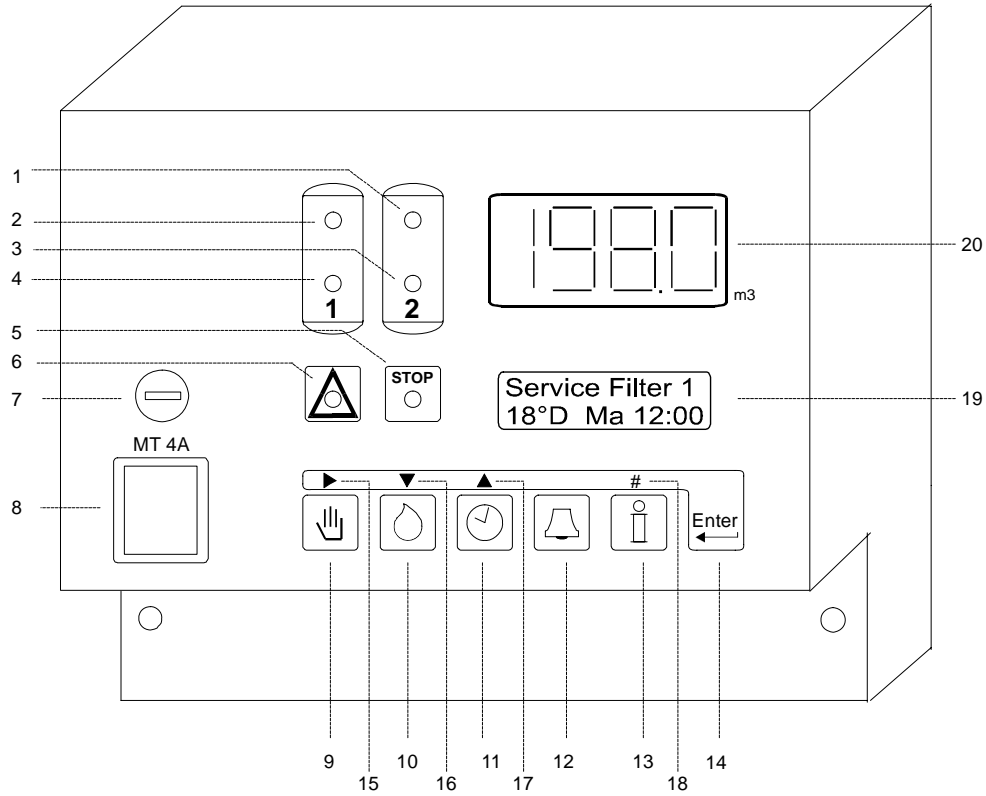

- | | | | |
|-----------------------|--------------------------|--------------------|--------------------------|
| 1 Service unit 2 | 6 Alarm | 11 Real Time Clock | 16 Next program step |
| 2 Service unit 1 | 7 Main fuse | 12 Reser | 17 Previous program step |
| 3 Regeneration unit 1 | 8 Main switch | 13 Information | 18 Number input |
| 4 Regeneration unit 2 | 9 Regeneration start | 14 Programming | 19 LCD - display |
| 5 Warning | 10 Supply water hardness | 15 Move cursor | 20 LED - display |



Status and Regeneration messages

LED - display.

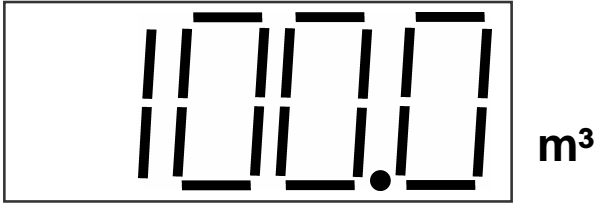

Whilst a unit is in service the LED - display indicates the remaining volume of water which can be softened before the next regeneration will be required.

When operating without a water meter, i.e. in time control, the display shows the full capacity between regeneration's.

During the regeneration of a simplex plant the display will read " 0 m³ ".

If the maximum value of 9999 is exceeded the LED display will show the text "OFL" as long as the value is to high.

NB! There is an additional "decimal point" in the bottom right hand corner of the display. This flashes when flushing has been commenced (see step 18 in the basic program).

LED - control lamps

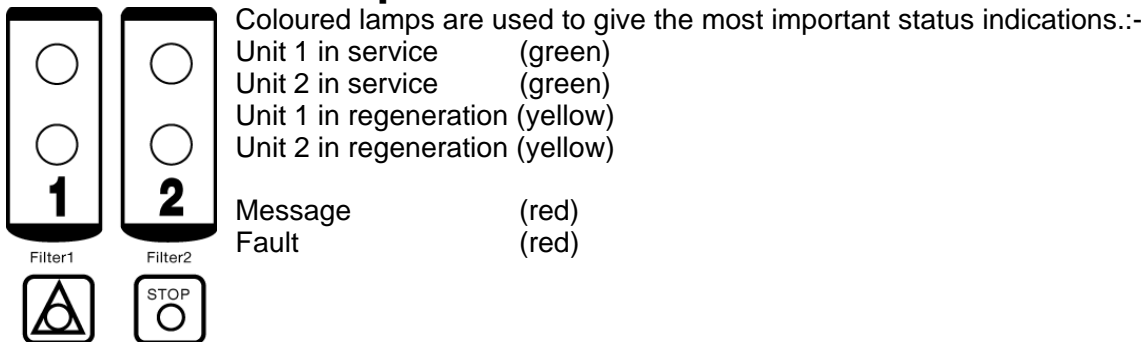

LCD - display.

Service status.

The first line of the LCD display indicates the actual condition of the plant, e.g. unit 1 in service.

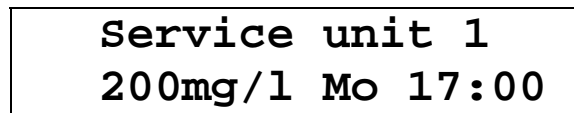

Usually during the service cycle the following information is given by the second line of the LCD:

- The left hand part of the line shows the incoming water hardness which has been programmed into the unit.
- The current time is displayed on the right.



However some operating regimes will produce alternative messages :-

or:

Service unit 1 72h Mo 17:00
--

- If the control has been set to initiate a regeneration after a fixed time interval the second line of the display will show the number of hours remaining until regeneration will take place and the current time.

or:

Service unit 1 Flush-time 20s
--

- The control can be programmed to give a signal, e.g. for a bleed valve, each time a predetermined volume of water has been supplied. When this output is active the second line of the display shows the remaining signal duration.

Regeneration status.

The first line of the LCD display indicates the actual condition of the plant, e.g. unit 1 in regeneration.

Regen. unit 1 Phase : 2 15m
--

The second line of the LCD display shows, the regeneration step or phase in progress and the time remaining in the step. If "Step: 0" is displayed it means that the additional routine will operate before regeneration can commence, similarly "Step: E" indicates that the additional routine is continuing beyond the end of the regeneration cycle. If required the duration and remainder of the additional routine can be displayed briefly by pressing the INFO key (see page 6).

Regen. unit 1 Wait for regen

At the start of a regeneration there will be checked if regeneration is allowed (prohibited regeneration, chemical tank empty, wait, minimum regeneration distance or ion exchange capacity exceeded).

The unit is then waiting for regeneration in this will be displayed in the LCD.



Changing and indication of program values.

The most important program values can be recalled and, changed if required, by pressing a key.

Hardness of the water supply.

Press the "Hardness" key, indicated by the symbol , to display the supply water hardness.

Water hardness:
220mg / l

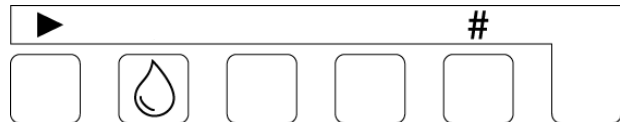

Should it be necessary to change the programmed value; the arrow key " ▶ " may be used to move the flashing cursor to the digit to be changed, and the Number key "#" to make the change.

A desired unit of hardness measurement may be selected (section 7 of the programming instructions), the following are available :-

Hardness units		Programmable range
°D	German hardness degrees	2 - 99
°F	French hardness degrees	4 - 199
°E	English hardness degrees	2 - 99
mg/l CaCO ₃	Milligrams per litre as CaCO ₃	40 - 1990
gpg	Grains per gallon	2 - 99

The controller automatically recalculates the capacity between regeneration's using the new value, at the initiation of the next regeneration cycle, as follows :-

$$\frac{\text{Column capacity [mg/l CaCO}_3\text{/m}^3\text{ of resin x m}^3\text{ of resin]}}{\text{Supply Water Hardness [mg/l ~ CaCO}_3\text{]}} = \text{Softened Water Capacity [m}^3\text{]}$$

Important Note! If a hard water blending by pass is used so that the water meter indicates the blended water capacity, it is essential to subtract the final, blended, water hardness from the value to be inserted.

Example:

supply water hardness = 300 mg/l CaCO₃ , blended water hardness = 120 mg/l CaCO₃

Thus a value of 180 mg/l CaCO₃ (300 mg/l CaCO₃ - 120 mg/l CaCO₃) must be programmed into the control.



Current Time.

Press the "Time" key indicated by the symbol , to display the current time.

Current Time
Mo 16:48



Should it be necessary to change the programmed value; the arrow key "▶" may be used to move the flashing cursor to the digit to be changed, and the Number key "#" to make the change.

Information DISPLAYS.

The "INFORMATION" key makes it possible to retrieve information, e.g. values from memory. Each time the "INFORMATION" key indicated by the symbol , is pressed a different piece of information is displayed :-

Software version

Software-version
ES2070SV1.00.00g

The software is regularly updated in the factory. Modifications are made in order to adapt the product in accordance technological changes and customer

Flush period.

Flushing
500l 350l 20s

The programmed volume between successive flush signals, the volume remaining to the next flush signal and the duration of the flush signal are displayed.

Regeneration time .

Regen.time [min]
Σ 125 rest 15

The duration of a complete regeneration cycle and the possible additional time which could be programmed are displayed.

Regeneration restrictions.

NoReg16:00-18:00
IntRg72 MinRg4

NoReg 16:00-18:00 / Regen 16:00 – 18:00 if the control has been set to prohibit / allowed regeneration between certain times (section 3 of the programming instructions), this part of the display shows the time between which regeneration is prohibited. Otherwise the display will read : NoReg---



IntRg 72 if the control has been set to initiate regeneration after a programmed time interval (section 4 of the programming instructions), this part of the display shows programmed time interval in hours. Otherwise the display will read : IntRg -.

MinRg 4 if the control has been set to give a minimum period between successive regeneration's (section 5 of the programming instructions), this part of the display shows the programmed time interval in hours. Otherwise the display will read : MinRg -.

Additional program 1

Additional prog1
Step:2 20m

If the additional program 1 has been selected (section 14 of the programming instructions), the selected start time and the duration of the additional program are displayed, if "Step 0" is displayed the additional routine will operate before regeneration can commence, similarly "Step: E" indicates that the additional routine will continue beyond the end of the regeneration cycle. If the program is activated the display shows how long it has left to run.

If additional program 1 is not selected, "No additional program" will appear in the display.

Additional program 2

Additional prog2
Step:2 30m

If the additional program 2 has been selected (section 14 of the programming instructions), the selected start time and the duration of the additional program are displayed, if "Step 0" is displayed the additional routine will operate before regeneration can commence, similarly "Step: E" indicates that the additional routine will continue beyond the end of the regeneration cycle. If the program is activated the display shows how long it has left to run.

If additional program 2 is not selected, "No additional program" will appear in the display.

Additional program 3

Additional prog3
Step:2 40m

If the additional program 3 has been selected (section 14 of the programming instructions), the selected start time and the duration of the additional program are displayed, if "Step 0" is displayed the additional routine will operate before regeneration can commence, similarly "Step: E" indicates that the additional routine will continue beyond the end of the regeneration cycle. If the program is activated the display shows how long it has left to run.

If additional program 3 is not selected, "No additional program" will appear in the display.

**Unit capacity.**

Unit capacity
150 m3

The calculated capacity between regeneration's is displayed.

Treated water produced.

Treated water
45367 m3

The total volume of water which has been treated by the plant.

Warning: This counter can be reset to zero by a service engineer, consult service logs for details of the value prior to reset.

Input 1.

Input 1
WM1- WM2- SP-

Indicates the current status of each input, the inputs are :-

WM1= watermeter1 WM2= watermeter2 SP =service stop

Inputs WM1 and WM2 are shown as active when the external contacts are closed.

Input SP is active when the external contact is open.

Active states are indicated by "|" after the input reference, inactive by "-".

Input 2.

Input 2
RC- WA- RS-

Indicates the current status of each input, the inputs are :-

RC = water meter, WA = wait, RS = regeneration start

Inputs WA, and RS are shown as active when the external contacts are closed.

Input RC is active when the external contact is open.

Active states are indicated by "|" after the input reference, inactive by "-".



Outputs.

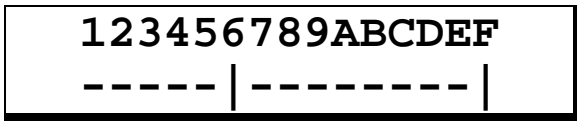

Indicates the current status of each output, " I " below an output number indicates an active output, " - " an inactive one.

Service - Telephone number.

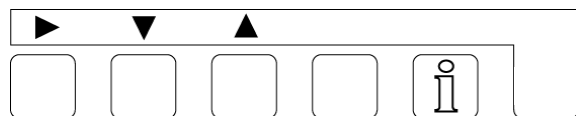
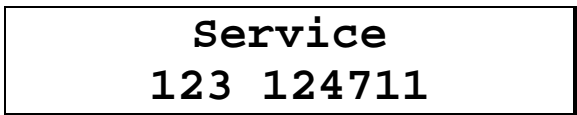

To change the telephone number. Select the digit using the " ▶ " key, the number can then be changed by using either the " ▼ " or " ▲ " key.

Maintenance.

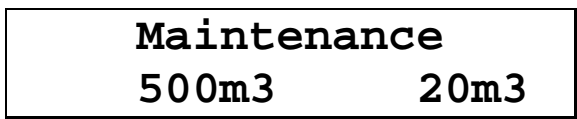

If the automatic maintenance required warning is programmed the pre set maintenance interval is displayed on left hand side of the second line and the quantity of treated water produced since the last maintenance visit is displayed on the right hand side of the second line.



Alarms / warnings.

When the equipment is operating, various messages may appear in the display, this facility can be used to drive relay outputs or to give alarms or warnings. The relay positions are indicated by red control lamps bearing symbols for "Attention" for messages and "Stop" for malfunctions. The programming of these functions is described in sections 20 and 21 the programming instructions.

Descriptive text appears in the LCD display, in addition to the fault or warning light indication.

Programmed capacity exceeded.

**Installation
Cap. exceeded**

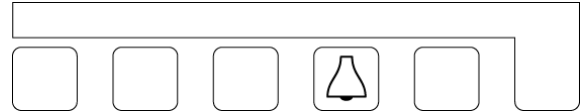

This message can only be displayed when controlling a duplex plant and appears if the working unit requires regeneration whilst the off line unit is in regeneration.

Possible causes when the plant is water meter controlled:

- Wrongly programmed capacity.
- Wrongly programmed incoming hardness.
- The water meter is faulty or of the incorrect type.
- Excessive demand for water e.g.. a large tank being filled very rapidly.

Possible causes when regeneration is remotely initiated by water analysis equipment signal:

- Faulty analytical equipment.
- Incorrect operation of analysis unit.
- Water analysis equipment too sensitive or giving spurious readings.
- Inadequate regeneration of the unit leading to shortfall in capacity.

IMPORTANT! In this condition if regeneration initiation is volume dependent, i.e.. by water meter, the on-line unit will begin to regenerate as soon as the other unit has finished it's regeneration.

If a salt saturator is being used and there is insufficient brine available for the second regeneration the second regeneration cycle must be prevented either by switching off the control or by giving a "wait" input. Once sufficient brine is available the second unit can be allowed to regenerate.

Press the "UNLOCK" key indicated by the symbol , in order to reset the warning or alarm relay. If the key is pressed a second time, the LCD display will also be reset, if there is only one filter in regeneration.



Electrical supply failure.

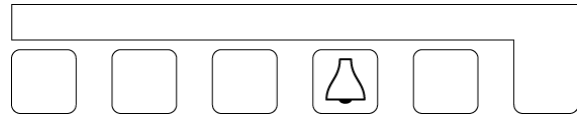
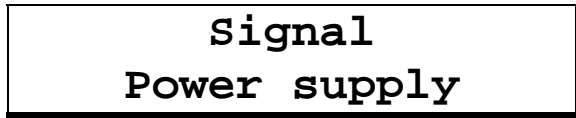

If there is a failure of the power supply no status information will be lost. The control panel "remembers" the condition it was in when the supply is interrupted.

IMPORTANT! If the plant is in a regeneration cycle when the power supply fails it is possible for the unit to become partially exhausted, by the passage of water to drain, if the water supply is maintained during the power failure.

In this situation the regeneration cycle should be terminated and a new cycle initiated first ensuring sufficient chemicals are available.

Press the "UNLOCK" key indicated by the symbol , in order to reset the warning or alarm relay and then reset the current time.

Refill chemical tank.

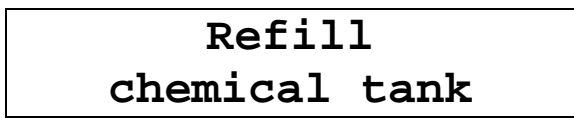

NOTE: This message can only appear only if there is a "regeneration chemicals" input connected.

Chemicals should be added to the chemical tank.

IMPORTANT! One regeneration cycle will be performed after this message appears. and regeneration may still be initiated by pressing the "REGENERATION START" key indicated by the symbol .

Press the "UNLOCK" key indicated by the symbol , in order to reset the warning or alarm relay. The message will then clear when regeneration chemicals are available.

With duplex plant operating in standby mode the standby unit will automatically be brought into service even though regeneration of the exhausted column cannot take place.



Wait regeneration.

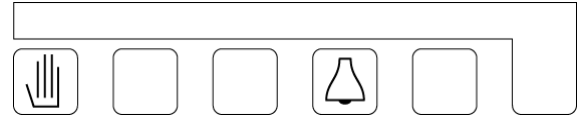
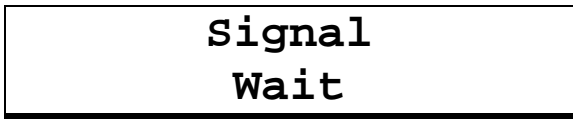

This message appears during the regeneration cycle only if there is a "Wait" contact, for example a water pressure switch intended to prevent regeneration when there is insufficient water pressure, connected.

Press the "UNLOCK" key indicated by the symbol , in order to reset the warning or alarm relay. This will abort any regeneration cycle which is in progress.

Important Note: If the manual regeneration key indicated by the symbol , is pressed the "Wait" signal is temporarily neutralised and the regeneration cycle will take place.

The alarm and warning relays and the LCD signals are cleared, as soon as the "wait" signal is removed. In order to prevent cancellation of the warning before the fault has been cleared it is not possible to manually reset the message relay.

With duplex installations, operating in standby mode, the stand by unit will be brought on-line if there is a "wait" signal when a regeneration cycle is initiated.

IMPORTANT Any additional program will be disabled.

Pre contact (regeneration pre initiation warning).



This message will only be appear, if selected (section 10 of the programming instructions).

Press the "UNLOCK" key indicated by the symbol , in order to reset the display and the alarm relay, if programmed. If the warning relay is programmed it cannot be cancelled manually. This is to prevent premature disconnection of, for example, water analysis equipment.

The display and the relay are automatically cancelled when the regeneration cycle is initiated.



Minimum inter regeneration time limit.

**Minimum regene-
ration period**

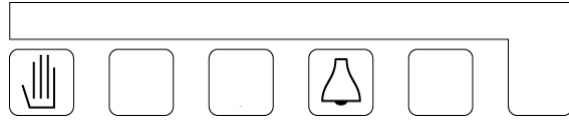

This message will only appear if a minimum interval between regeneration's has been programmed (section 5 of the programming instructions).

Possible causes when the plant is controlled by a water meter:

Wrongly programmed capacity.

Wrongly programmed incoming water hardness.

The water meter is faulty or of the incorrect type.

Excessive demand for water e.g. a large tank being filled rapidly.

Possible causes when activated by an external water analysis equipment signal:

Poor water quality from a column which has been on standby for some time, due to the contra ion effect. this can be overcome by fitting a flushing valve or circulation pump in the system or by reducing the sensitivity of the analytical equipment.

Press the "UNLOCK" key indicated by the symbol , to restore the display and reset the alarm relay, if programmed.

Maintenance.

**Signal
Maintenance**

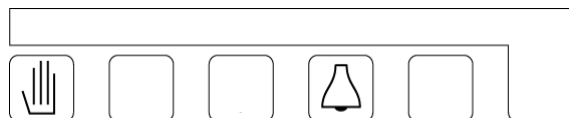

This message can only appear when the facility for giving an automatic warning that maintenance is due has been selected in section 24 of the programming sequence.

Press the "Reset" key with the  symbol in order to reset the alarm relay, if programmed, and call your maintenance company. The LCD display can only be cleared by trained personnel.



Manual regeneration initiation.

A regeneration may be manually initiated at any time. Press the "REGENERATION INITIATION" key indicated by the symbol , after 5 seconds regeneration of the on line unit is initiated.

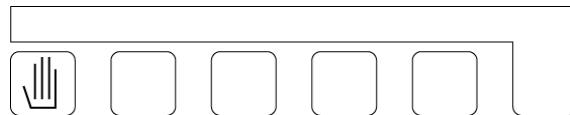

- With duplex installations operating in standby mode the stand by unit is brought into service.
- If the prohibited time function is already activated the regeneration will initiate, i.e. the prohibited time function will be overridden.
- The counter is reset to the calculated capacity after the regeneration.
- If the unit has been set to initiate a regeneration after a fixed time has elapsed, (section 4.1 of the programming instructions) the interval timer is reset to its programmed value and restarted.
- If a minimum time between regeneration's has been programmed (section 5.1 of the programming instructions), the timer will be overridden and reset.



Remote control.

The following functions may be remotely controlled by switch contacts connected to the terminal strip of the controller :-

"Watermeter1" and "Watermeter2" inputs (WM1,WM2)

"Contact head"/"reed" water meters give a pulse each time a fixed volume of water has registered e.g. of every 100 litres. These pulses are counted by the controller and once the calculated capacity has been supplied a regeneration is initiated.

The controller cannot accept more than 10 pulses per second.

"Stop Service" input (SP)

The service valves will open or close in response to the input.

APPLICATION: Treated water storage tank level control.

"Chemicals low" input (RC).

This input signal can be used to monitor the chemical tank and prevent regeneration if there are insufficient chemicals available.

The warning will not immediately prevent a regeneration, because it is assumed that there will be sufficient chemicals present for one regeneration. By pushing the key "REGENERATION INITIATION" indicated by the symbol , it will be possible to override the warning and initiate a regeneration.

IMPORTANT! The input signal facility does not monitor the chemical tank until 3 hours after a regeneration has taken place, however if a regeneration is initiated during this time the chemical tank is checked. The facility is disabled during regeneration.



"Wait " input (WA).

The input signal can be used to hold off or stop a regeneration cycle. The input is active only during a regeneration cycle.

With duplex installations, when the signal is active, regeneration of an exhausted unit can not be initiated but, if the plant is operated in standby mode, the stand by unit will be brought on line.

After the "WAIT" signal is cleared the regeneration cycle is commenced or continued.

When "REGENERATION INITIATION" indicated by the symbol , is pressed, the "WAIT" signal will be suspended for the duration of the regeneration cycle.

When using the fast program key facility, (see special functions page 17) it is possible to step forward to the next regeneration step.

"Start" input (RS).

This input signal can be used to initiate a regeneration of the plant by remote means, e.g. a push button, or water monitoring equipment. When operating a duplex plant in standby mode the standby unit will be brought on line. A start-up delay can be set at program step 23.2

If a minimum interval between regeneration's has been programmed (section 5 of the programming instructions) if an attempt is made to initiate a regeneration during this interval the "minimum regeneration time" warning will be displayed. Regeneration will not be initiated, manual initiation will be required and the alarm must be manually reset. (see page 13.)

On a simplex plant the input is disabled during regeneration and only becomes available again once the regeneration is complete and the time entered at program step 23.1 has elapsed.

In double filter systems the input is blocked after the start of regeneration for the time entered at program step 23.1. Then if a start signal is present the report "system overloaded" is shown, since evidently both filters are exhausted.

NOTE The time entered at program step 23.1 is also activated after a power loss to allow for a measuring device to take a new measurement.



Special functions.

These functions should only be used by a trained specialist, ill considered use of these functions will cause operating problems.

Duty changeover without regeneration.

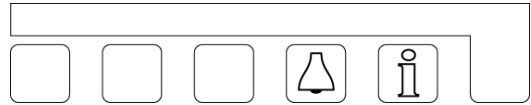



Press the "UNLOCK" key  and the "INFORMATION" key  simultaneously. On a duplex plant duty changeover takes place after 2 seconds delay.

IMPORTANT There are separate counters for each exchange column. If an almost exhausted column is brought into service, then that unit may require regeneration whilst the other unit is in regeneration. The "period capacity exceeded" warning will be displayed.



Regeneration of the standby unit.



Press the "TIME" key  simultaneously with the "UNLOCK" key . On a duplex plant regeneration of the stand by unit is initiated after 2 seconds delay.

Regeneration stop.



Press the "REGENERATION INITIATION" key  and the "UNLOCK" key  simultaneously. The regeneration in progress will be aborted after 2 seconds and the plant will be return to the normal service condition.



IMPORTANT Pilot stagers for manifold valves may not have an automatic "return to service" facility when the control is returned to the service condition, this type of stager will hold the plant in regeneration mode and will no longer be synchronised with the controller.

IMPORTANT If chemicals has been drawn into the plant it will be necessary to rinse the chemical's out before allowing the plant to supply water to service.

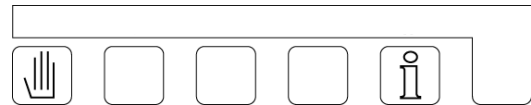

Fast program facility.



Press the "REGENERATION INITIATION" key  and the "INFORMATION" key  simultaneously, after 2 seconds delay the internal timer switches from minutes to seconds for the remainder of the current program step, at the end of the current step the timer returns to normal, the next regeneration step proceeds normally.

IMPORTANT When cycling through regeneration steps, sufficient time must be allowed between steps to permit the regeneration control valve to synchronise with the controller.

IMPORTANT If chemical has been drawn into the plant it will be necessary to rinse the chemicals out before allowing the plant to supply water to service.

NOTE The fast program option can not be initiated during a pulse for pulse or external control.

Flush ON/OFF.





Press the "Unlock" key , and the "ENTER" key simultaneously.

After 2 seconds delay the flush will commence. If the flush is already in operation, using this key combination will end the flush period.

Regeneration without counter reset.



For maintenance purposes, it is possible to initiate a regeneration which will not reset the counter or recalculate the operating capacity.

Press the "HARDNESS" key  simultaneously with "UNLOCK" key .

With simplex installations regeneration is initiated without resetting the counter and without recalculation of the unit capacity.

With duplex installations regeneration of the stand by unit is initiated. If regeneration of the duty unit is required first initiate duty changeover as described above (see "**Duty changeover without regeneration initiation**"). The "**Regeneration stop**" and "**Fast program**" facilities are both available, in this regeneration cycle.

IMPORTANT If chemical has been drawn into the plant it will be necessary to rinse the chemicals out before allowing the plant to supply water to service.



Setting and changing of initial values.

During the commissioning of a water softener the basic parameters for the installation must be programmed into the controller. These values can be modified later but they will not be corrupted or lost by an electrical supply failure.

- Changes to the basic values should only be made by trained personnel.
- Note the basic values in the spaces provided in the programming diagram and keep this handbook in a safe place for use by service and maintenance personnel.
- A change to the basic values is possible at any time. The majority of the changes however only take effect after initiation of the next regeneration cycle.
- A number of keys have dual functions.

1. Press the "ENTER" key. In order to overwrite the existing program this key must be held down for 4 seconds, then the basic values are ready for modification.

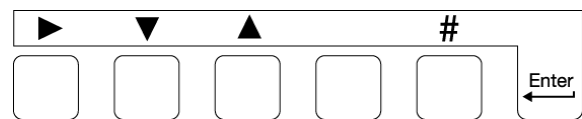

The following message appears in the LCD



the following message appears four seconds later



NOTE For steps 2 and 3 the "ENTER" key must be held down.

2. To change the **language in the LCD** display hold the "#" key down and use the "▶" key to move the cursor to the symbol of the country with the desired language.
3. The first and succeeding steps of programming can be entered by pressing the "▼" key.
4. With the "▲" key it is possible to return to the preceding step.

Note: The controller is still in the program mode. Do not keep the "ENTER" key pressed down any longer. To cease programming press the "ENTER" key at any time. The programming mode will be abandoned automatically if no key is pressed for approximately two minutes.

5. With the "▶" key it is possible to move the cursor, YES/NO choices can be made affirmative by moving the cursor to the Y key, and negative by moving it to the N key.
6. To modify numeric values move the cursor to the digit to be modified and then use the "#" key to change the value.

IMPORTANT

If a filter is in regeneration or waiting for regeneration the programming function will be disabled.



1. Installation

Step nr:	1.1
Filter:	1 2-

Select the number of the connected filter column(s).

Step nr:	1.2
Number in serv	1

On duplex installations program how many columns should be in service position.
(Only to program if two filters are selected in step 1.1)

Step nr:	1.3
Main valve on	Y/N

In simplex or parallel mode you can program if the service valve is opened when the unit is waiting for regeneration because of a empty chemical tank.

Step nr:	1.4
Main valve on	Y/N

In alternating or parallel mode you can program if the service valve is opened when an other unit is in regeneration.

If the installation is programmed for regeneration before service the valve is always closed during this situation.

2. Pre service regeneration.

Step nr:	2.1
Pre regen.	Y/N

If the treated water is used for drinking purposes then it is important to prevent bacterial growth. A stand by unit could possibly cause contamination due to bacterial growth during a long period off line. Regeneration can be programmed to take place immediately prior to the unit coming into service. Regeneration is held in abeyance until the duty unit is "exhausted".

Important The additional water which will be supplied at the end of the duty period must be allowed for in setting the operating capacity if this facility is used.



3. Prohibited regeneration period.

Step nr:	3.1
Delayed	B A N

A regeneration may be started at any time of the day but, for operational reasons, there may be times when regeneration would be undesirable e.g. the water pressure may be too low or demand may be high. In standby duplex mode, the standby unit will be brought into service and the exhausted unit will regenerate at the end of the prohibited period.

If this step is programmed at No then you will go to step 3.6.

B = During the programmed days (step 3.2) and times (step 3.3 and 3.4) a regeneration will be blocked.

A = During the programmed days (step 3.2) and times (step 3.3 and 3.4) a regeneration will be allowed.

N = No time control for a regeneration start

Step no.:	3.2
S- M- T- W- T- F- S-	

Select the day when the time control for regeneration must be active. "-" = not activated, "|" = activated

Step no:	3.3
Starttime	6:30

Enter the time at which the blocked / allowed period commences.

Step no:	3.4
Stoptime	18:30

Enter the time at which the blocked / allowed period ends.

Step no:	3.5
Main valve on	Y/N

For a simplex installation, it is possible to choose whether the outlet/supply valve (SV) remains open until regeneration starts or is closed immediately.

If the outlet valve remains open, it is important to ensure that the exchange column is able to deliver treated water if the regeneration warning is given before the column is exhausted, (see programming steps 9.1 – 9.3).

If the outlet valve is closed immediately provision must be made for the lack Of water or a reservoir of treated water must be provided sufficient for the prohibited period and the regeneration period

With a duplex plant operating in parallel then a decision must be made whether the outlet valve for the exhausted column should remain open until the start of the regeneration or should close leaving only one unit in service.

If the installation is programmed for regeneration before service the valve is always closed during this situation.



3. Starting on real time clock

Step no.:	3.6
Time start	Y/N

A regeneration can be started depending of the real time clock.
There is the possibility for programming three starting times at one day
If this step is programmed at No then you will go to step 4.1.

Step no.:	3.7
S- M- T- W- T- F- S-	

Select the day(s) for starting regeneration of the unit in service at the time programmed in step 3.8. "-" = not activated, "|" = activated

Step no.:	3.8
Starttime	00:30

Enter the time at which the unit in service will go into regeneration.

Step no.:	3.9
S- M- T- W- T- F- S-	

Select the day(s) for starting regeneration of the unit in service at the time programmed in step 3.10. "-" = not activated, "|" = activated

Step no.:	3.10
Starttime	05:30

Enter the time at which the unit in service will go into regeneration.

Step no.:	3.11
S- M- T- W- T- F- S-	

Select the day(s) for starting regeneration of the unit in service at the time programmed in step 3.12. "-" = not activated, "|" = activated

Step no.:	3.12
Starttime	10:30

Enter the time at which the unit in service will go into regeneration.



4. Time controlled regeneration

Step nr:	4.1
Interim start	Y/N

Regeneration can be initiated at fixed time intervals. This operating mode is selected if a water meter is not desired either because the water usage is regular and predictable or for operational reasons.

Sometimes this mode of operation is selected where there is a danger of micro organism formation within the unit due to a prolonged standby period. The facility is used to override volume dependant or quality dependant initiation.

At each time controlled regeneration, the water meter counter is reset.
If this step is programmed at No then you will go to step 5.1.

Step nr:	4.2
Period	72h

A time period of between 1 to 999 hours between regeneration's may be programmed.

IMPORTANT! With installations utilising brine tanks it may be necessary to await the availability of full strength brine, the actual time will depend upon the type of brine system used but could exceed 4 hours.



5. Minimum time between regeneration's.

Step nr:	5.1
Min.reg.time	Y/N

Based on the capacity of the installation, the incoming water hardness and flow rate, the minimum time between two regeneration cycles can be calculated.

With installations utilising brine tanks it may be necessary to allow time for full strength brine to be produced, the actual time will depend upon the type of brine system used but could exceed 4 hours.

When there are very large requirements of water, for instance when filling a large tank, if this minimum time requirement is not taken into account and the plant may be insufficiently regenerated because of unsaturated brine.

If a water softener installation is also equipped with water hardness monitoring equipment, the minimum time period between regeneration's must be programmed. Otherwise, should there be a defect e.g. with the monitoring equipment the unit will continuously regenerate.

Step nr:	5.2
Period	4h

The minimum time between two regeneration's can be anything between 1 and 999 hours.

Step nr:	5.3
Make up reg	Y/N

You can determine whether the regeneration is to be carried out immediately after the end of the 'minimum regeneration distance'(program at Yes) or whether the next regeneration has to be started manually. (program at No).

Step nr:	5.4
Main valve on	Y/N

When the message 'minimum regeneration distance' is displayed, you can determine whether the service valve is to stay open until regeneration is initiated with the possibility that it will supply incompletely treated water or whether that valve should close with the result that the system does not supply any more water.

Note : Not selectable in alternating service as this system switches over to the standby filter.

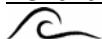

6. Water meter

Step nr:	6.1
Watermeter	Y/N

Using a contact head/reed water meter, the volume of treated water produced is measured and, when the pre-programmed quantity of water has been supplied, regeneration is initiated.

The LED display usually shows the capacity remaining i.e. the amount of water which can be treated before regeneration is required.

NOTE: If no water meter is used (e.g. regeneration takes place only at time intervals), the system's full capacity is always shown.

Step nr:	6.2
Liter/pulse	1001

The impulse rate (k factor) of the water meter can be programmed for values of between 1 and 9999 litres per pulse/contact closure.

Step nr:	6.3
WM > 1	Y/N

You can determine whether the installation has one water meter or each unit has his own water meter.

If programmed for one water meter the water meter should be connected to the input WM1.

If programmed for more water meters the water meter should be connected to input corresponding to the unit.



7. Incoming water supply hardness.

Any of the following units of measurement of water hardness can be used when operating the controller:

°D = German water hardness mg/l = parts per million CaCO₃
 °F = French water hardness gpg = Grains per gallon
 °E = English water hardness

A conversion table for these units of water hardness is given below:

	°D	°F	°E	mg/l CaCO ₃	gpg	mmol/l
°D	1	1,78	1,25	17,85	1,04	0,18
°F	0,56	1	0,70	10,00	0,58	0,10
°E	0,80	1,43	1	14,30	0,83	0,14
Mg/l CaCO ₃	0,056	0,10	0,07	1	0,058	0,01
gpg	0,96	1,71	1,2	17,1	1	0,17
mmol/l	5,60	10	7,02	100	5,82	1

IMPORTANT! The incoming water hardness is not entered as part of this basic program routine. Please see page 4 for details of how to program in the hardness.

Step nr: 7.1

°D °F °E mg gpg



8. Exchange capacity.

Step nr:	8.1
Capacity	1800

The unit of exchange capacity is dependant on the unit chosen in step 7. It gives the amount of softened water in m^3 as indicated in the chosen unit of hardness.

The amount of water which can be softened by each unit is automatically calculated as follows:

$$\frac{\text{Exchange capacity [mg CaCO}_3\text{]} \times 1000}{\text{Water hardness [mg/l CaCO}_3\text{]}} = \text{Softened water capacity [m}^3\text{]}$$

Example 1:

$$\frac{36000 \text{ mg CaCO}_3 \times 1000}{360 \text{ mg (l CaCO}_3\text{)}} = 100 \text{ m}^3$$

or

Example 2:

$$\frac{2020 \text{ °F m}^3}{40 \text{ °F}} = 50,5 \text{ m}^3$$

The exchange capacity can be entered as a numeric value in the range of 10 and 655,350.

IMPORTANT Regardless of whether the installation is a simplex, duplex plant only enter the capacity of one exchange column.



9. Pre regeneration signalling

Step nr:	9.1
Pre contact	Y/N

It is sometimes necessary to give a warning or to signal to another unit before the duty water softener is exhausted.

Step nr:	9.2
Capacity [%]	80

A limit value of anything between 1% and 99% of the operating capacity may be selected. For example, with a capacity of 180m³ between regeneration's and a selected limit of 80% the contact will be made at 144m³.

Step nr:	9.3
Reg.start	Y/N

This facility may be used to initiate regeneration of a simplex plant, and is used in conjunction with a prohibited regeneration period. (Section 3 above.) Regeneration will start at a fixed time, the end of the regeneration prohibited time, but only after a predetermined volume of water has been treated.

This allows a quantity of treated water to be held in reserve for use the following day. For example with a capacity of 180 m³ and pre contact at 80% there would be a treated water reserve capacity of 36 m³. When less than 36 m³ of treated water capacity remains a regeneration will take place when the next permitted regeneration time is reached.

IMPORTANT Untreated water must not be allowed to reach the user, it is important that there be sufficient reserve capacity to provide water during the time between the pre contact and the delayed regeneration cycle.

10. Number of regeneration switch phases

Step nr:	10.1
Stage	4

Enter the number of regeneration phases for individual valve triggering (max. 8 phases).



11. Electrical control.

Step nr: 11.1
1-2-3-4-5-6-

Select which of the free programmable outputs (OUT1 – OUT6) are reserved for a valve function. If an output is programmed for a valve, the corresponding programming for this output in step 14 will not be available.

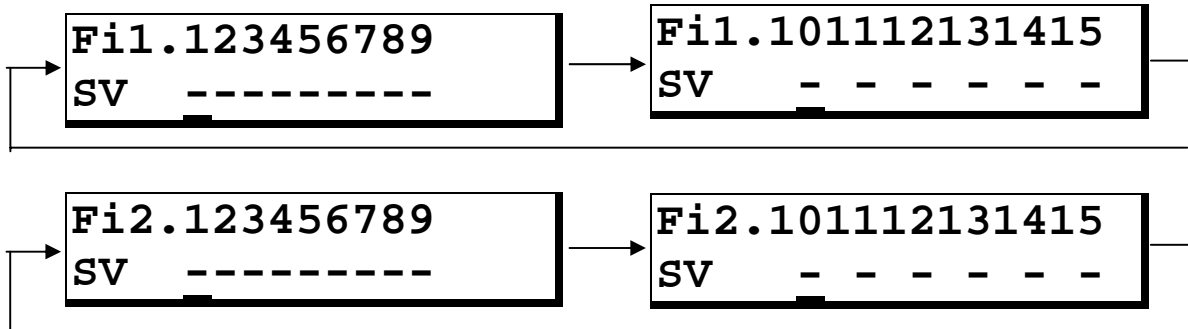

This program step determines which valves are opened in which phase.

Select the phase by moving the cursor to the phase indication using the “▶” key, select the required phase using the “#” key.

The first line of the LCD display shows valve numbers 1-9 during the phases of filter 1 or filter 2. The second line displays a phase and under the numbers 1-9 the relevant switch state in that phase.

Here “|” means relay activated and “-“ means relay not activated.

ATTENTION: In duplo installations a relay will be activated if for at least one filter the relay is programmed at “|”.

If one of the free programmable outputs is selected for a valve function, the display for the valve numbers 10-15 will be displayed also. If the cursor is under the number 9 and the key “>” is pressed the number 10-15 will appear in the display.

If an programmable output is not selected for a valve function then under the corresponding number the character ‘x’ will be displayed and the programming for this output will be skipped.

In addition to the number of phases entered at program step 10.1 the service position, the stop position in service and the stop position during regeneration are also programmed (display : SV, SP or HO phase).

The stop position in service can be activated by activating the input ‘Stop Service’ (SP), by ‘capacity exceeded’, by ‘delayed regeneration’, by minimum regeneration distance’, by the input ‘chemical tank’ (RC), by the input ‘Wait’ (WA) at the start of a regeneration and by ‘additional program before regeneration’.

ATTENTION : During above mentioned situations the programming of the service valve for the corresponding situation has to be programmed at ‘No’.

The stop position during regeneration can only be activated by activating the input ‘Wait’ (WA).



13. Regeneration times.

The duration of each stage of regeneration must be programmed. The number of stages was selected in programming section 10.1. No times need to be programmed for the "SERVICE" condition.

In this step the number and duration of the regeneration step must be entered.

Any value between 1 and 999 minutes can be programmed in.

Step nr:	13.1
Time phase 1	10m

For example for a 3 step regeneration.

Backwash Stage 1: 10 min.

Injection/slow rinse Stage 2: 60 min.

Fast rinse Stage 3: 15 min.

To adjust the step times, position the cursor to the step number using the "▶" key, select the required step using the "#" key then position to the figure to be changed using the "▶" key and alter the value using the "#" key.

To adjust another step time, reposition the cursor and proceed as above.



14. Programmable outputs

If an output (step 10.1) is programmed for a valve, the corresponding programming for this output in step 14 will not be available.

There are six programmable potential free outputs for the following output functions :

AD1 = Additional program 1	RE = Regeneration output
AD2 = Additional program 2	AL = Alarm
AD3 = Additional program 3	MF = Warning
FL = Flushing	FP = Flow pulse
HP = Transport pump	- = No function

AD1, AD2, AD3 = An additional program during regeneration. This allows control of a valve or pump before, during or after a regeneration. It is possible to program the output to operate for a time period of between 1 and 999 minutes. (Resp. Program step 15.1-15.3, 16.1-16.3 and 17.1-17.3)

RE = Regeneration output during regeneration (no further programming step).

AL = Alarm output. (Program step 20.1 and 20.2)

MF = Malfunction output . (Program step 21.1 and 21.2)

FL=A timed flush signal which can be used to open a dump valve flushing the plant to drain each time a pre-set volume of treated water has been produced. It is possible to program duration's of between 1 and 999 seconds and volumes between successive flushes of between 1 and 99,999 litres (Program step 18.1-18.2)

FP = Flow pulse Every pulse of the water meter(s) will be passed to the output with programmable pulse time (Program step 19)

Step nr: 14.1 AD1 FL HP -	(output function for OUT1)
Step nr: 14.2 AD2 FL FP -	(output function for OUT2)
Step nr: 14.3 AD3 FP HP -	(output function for OUT3)
Step nr: 14.4 RE FL FP -	(output function for OUT4)
Step nr: 14.5 AL FL HP -	(output function for OUT5)
Step nr: 14.6 MF FP HP -	(output function for OUT6)



15. Additional program 1

Step nr: 15.1
Start phase: 2

It is possible to use the additional program before the start of the actual regeneration, that means before the regeneration valve is initiated.

In this case program Start phase: 0

This function can also be used to flush out the stand by unit of a duplex

plant prior to bringing it into service.

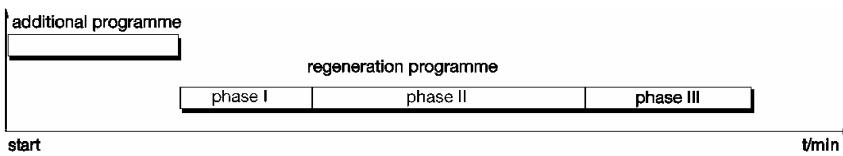

Example: additional program before the actual regeneration

same or of even longer duration than the regeneration program.

The additional program and a regeneration cycle can also begin simultaneously. The additional program can either be shorter, the

In this case program in the phase of regeneration which is to start simultaneously with the start of the additional program.

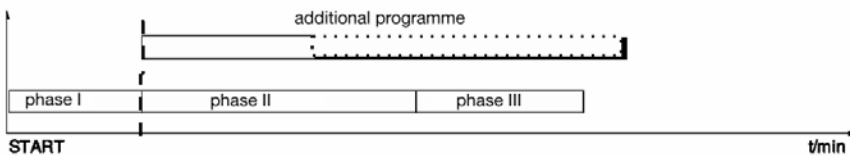

Example: additional program starts with the second step of regeneration

The additional program can follow the regeneration cycle, so that, for example, chemical tanks may be refilled, if required.

In this case program Start phase: E

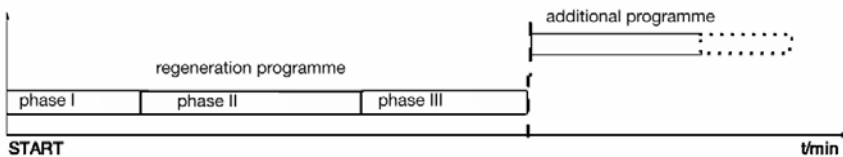

Example: additional program follows the regeneration cycle

Step nr: 15.2
Time 20m

The duration of the additional program (Relay on / Relay off) can be programmed for between 1 and 999 minutes.



Step nr:	15.3
Switch SV	Y/N

If the additional program is active before the actual regeneration ("pre regeneration" and "flushing before service" are not programmed) then a decision has to be made :

For a simplex installation,

When should the outlet valve be closed? At the start of the additional program? (Change over "Y") Or as the additional program finishes, i.e. at the initiation of the regeneration cycle? (Change over "N")

For a duplex installation,

Operating in stand by mode should the stand by unit be brought on at the start of the additional programme (Change over "Y") or at the start of the regeneration of the exhausted unit (Change over "N")

ATTENTION : If the outlet valve is closed during the additional program before the actual regeneration, then the check for allowing regeneration will be made before starting the additional program otherwise this check will be made after the additional program.

16. Additional program 2

See also Step 15 for details.

Step nr:	16.1
Start phase:	2

You can determine the start phase for additional program 2.

Step nr:	16.2
Time	30m

The duration of the additional program can be programmed for between 1 and 999 minutes.

Step nr:	16.3
Switch SV	Y/N

SV closed (program Yes) or opened (program No) during additional program before regeneration.

17. Additional program 3

See also Step 15 for details.

Step nr:	17.1
Start phase:	2

You can determine the start phase for additional program 3.

Step nr:	17.2
Time	40m

The duration of the additional program can be programmed for between 1 and 999 minutes.

Step nr:	17.3
Switch SV	Y/N

SV closed (program Yes) or opened (program No) during additional program before regeneration.



18. Flush

Step nr:	18.1
Flush time	20s

Calculate the flush time (range 1 to 999 seconds)

Step nr:	18.2
Interv.	500l

This is the setting for the amount of treated water to be supplied between flushes.
The permissible range is 1 to 99.999 litres.

19. Flow pulse

Step nr:	19.1
Pulse time	1.0s

For every impulse of the water meter the relay with output function FP operates once.
These output pulses can be used for control of a dosing pump or a dosing monitoring system or to operate a remote flow rate measuring/control system.

If the interval between successive water meter pulses/contacts is less than the programmed output duration the impulses are stored by the control and the output relay reactivated the appropriate number of times. There is an interval of 0,5 sec between output pulses.

Programmable pulse time (range 0,2 to 999,9 seconds).

20. Alarm

Step nr:	20.1
PF- DI- DY- WA-	

You can determine on which event the output function AL has to be activated.

PF = power failure

DI = minimum regeneration distance(not programmable if step 5.1 at No)

DY = prohibited regeneration (not programmable if step 3.1 at No)

WA = input 'Wait'

Step nr:	20.2
RC- CE- PC-	

You can determine on which event the output function AL has to be activated.

RC = chemical tank

CE = installation capacity exceeded (not programmable if simplex installation)

PC = pre contact (not programmable if step 9.1 at No)



21. Warning

Step nr: 21.1 PF- DI- DY- WA-

You can determine on which event the output function MF has to be activated.

PF = power failure

DI = minimum regeneration distance (not programmable if step 5.1 at No)

DY = prohibited regeneration (not programmable if step 3.1 at No)

WA = input 'Wait'

Step nr: 21.2 RC- CE- PC-

You can determine on which event the output function MF has to be activated.

RC = chemical tank

CE = installation capacity exceeded (not programmable if simplex installation)

PC = pre contact (not programmable if step 9.1 at No)

22. "Wait" input

Step nr: 22.2 Main valve on Y/N

You can determine whether the service valve should be opened or closed during input Wait was detected at the start of the regeneration.

Note : Not selectable in alternating service as this system switches over to the standby filter.



23. "Start" input

Regeneration delay 1

Step nr:	23.1
Reg. Delay 1	600s

This time setting (0-999 seconds) determines the number of seconds the "Start" input is blocked after a new regeneration or a filter changeover, for instance to wait for a new analysis by a water hardness meter.

Regeneration delay 2

Step nr:	23.2
Reg. Delay 2	10s

This time setting (0-999 seconds) determines a delay period for the "Start" input.

24. Maintenance

You can determine whether a "MAINTENANCE" message is shown on the LCD display after a set supply quantity and whether the relay outputs "warning" and/or "fault" are activated when this message is displayed.

NOTE: This program step can only be called up by the appropriate service company.

Step nr:	24.1
Maintenance	Y/N

Step nr:	24.2
Interv.	50000m3

You can set a service interval from 1 to 999,999 m3.

Step nr:	24.3
Alarm	Y/N

The fault relay can be activated in addition to the LCD display.

Step nr:	24.4
Warning	Y/N

The report relay can be activated in addition to the LCD display.



Connection terminals ES2070 SV

ES2070 SV - 24 V : no control lamp in the main switch

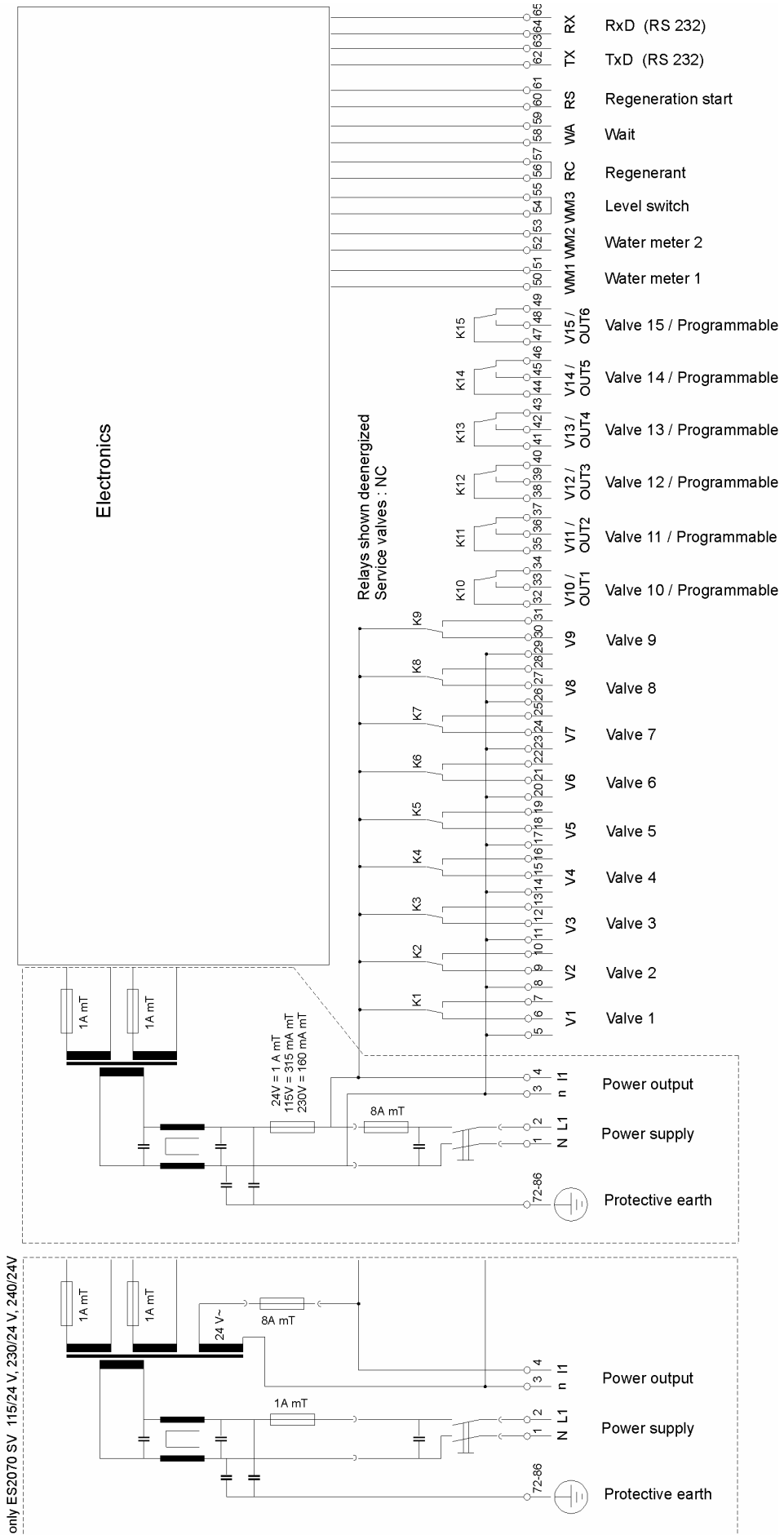



Technical specifications

Electrical supply:	24 V \pm 10% 50-60 Hz fuse 8 A mT 115 V \pm 10% 50-60 Hz fuse 8 A mT 230 V \pm 10% 50-60 Hz fuse 8 A mT 115/24V \pm 10% 50-60 Hz fuse 8 A mT 230/24V \pm 10% 50-60 Hz fuse 8 A mT 240/24V \pm 10% 50-60 Hz fuse 8 A mT
Power consumption control circuit:	96 VA
Powered outputs:	Up to a maximum total load of 8A
Potential free outputs:	Maximum load on relay contacts 250V / 8A
Potential free inputs:	Contacts loaded up to a max. 9V 8 mA
Protection class:	IP 65
Ambient temperature:	0 - 50 C
Weight:	approximately 4 kg
Dimensions:	W x H x D = 390 x 318 x 160

Equipment is protected against zero voltage.

 **ATTENTION:** Some external relays, magnetic switches, magnetic valves, etc. can cause undesirable interference pulses when switching off. For this reason it is recommended to provide the components mentioned, in advance, with a "RC-network".
Inquire at the supplier of the components mentioned for the correct type of RC-network.

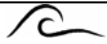

Declaration of conformity

Declaration of conformity of the product with the essential requirement of the EMC directive 89 / 336 / EEC.

Product description

Product name : Controller for water softening installations
Product type : ES2070
Manufacturer : EWS Equipment for Water treatment Systems International B.V.

Product environment

This product is intended for use in residential en light industrial environments.

Emission standard : EN 55011
Immunity standard : EN 50082-1

Report

Report number : EWS / EMC / 0111

This declaration was issued by :

Date : 04 - 12 - 2001

Name : D.H. Naeber

Signature :



FIVE-YEAR CONTROLLER LIMITED WARRANTY

LIMITED WARRANTY

EWS International (hereafter EWS) warrants her products free from defects in material and workmanship under the following terms.

In this warranty, "Products" shall be taken to mean all devices that are supplied pursuant to the contract with exception of software.

VALIDITY OF THE WARRANTY

Labour and parts are warranted for five years from the date of the first customer purchase. This warranty is only valid for the first purchase customer.

Notwithstanding the warranty period of five years as mentioned above - while upholding the remaining provisions – a warranty period of three months applies to the supply of software.

COVER OF THE WARRANTY

Subject to the exceptions as laid down below, this warranty covers all defects in material or workmanship in the EWS products. The following are not covered by the warranty:

- 1) Any product or part not manufactured nor distributed by EWS. EWS will pass on warranty given by the actual manufacturer of products or parts that EWS uses in the product.
- 2) Any product, on which the serial number has been defaced, modified or removed.
- 3) Damage, deterioration or malfunction resulting from:
 - a) Accident, misuse, neglect, fire, water, lightning or other acts of nature.
 - b) Product modification or failure to follow instructions supplied by the products.
 - c) Repair or attempted repair by anyone not authorized by EWS.
 - d) Any shipment of the product (claims must be presented to the carrier)
 - e) Removal or installation of the product
 - f) Any other cause, which does not relate to a product defect.
 - g) Cartons, equipment enclosures, cables or accessories uses in conjunction with the product.

FINANCIAL CONSEQUENTES

EWS will only pay for labour and material expenses for covered items, proceed from repairs and updates done by EWS at the EWS location. EWS will not pay for the following:

- 1) Removal or installations charges at customers and/or end user location.
- 2) Costs for initial technical adjustments (set-up), including adjustment of user controls or programming.
- 3) Shipping charges proceed from returning goods by the customer. (Shipping charges for returning goods to the customer are for the account of EWS).

All the costs which exceed the obligations of EWS under this Warranty, such as, but not limited to, travel and accommodation costs and costs for assembly and dismantling are for the account and risk of the customer.

WARRANTY SERVICE

In order to retain the right to have a defect remedied under this warranty, the customer is obliged to:

- 1) Submit complaints about immediately obvious errors related to the products delivered, in writing within eight days of the delivery of the products and submit complaints about shortcomings relating to the products delivered, which are not visible, within eight days of their being discovered.
- 2) Return defected products for account and risk of the customer. Costs for this shipment will not be reimbursed by EWS. The products may only be returned following express, written permission from EWS. Returning the products does not affect the obligation to pay the invoiced amounts.



- 3) Present the original dated invoice (or a copy) as proof of warranty coverage, which must be included in any [of the] return shipment of the product. Please include also in any mailing a contact name, company, address and a description of the problem(s).

LIMITATION OF IMPLIED WARRANTIES

Except where such disclaimers and exclusions are specifically prohibited by applicable law, the foregoing sets forth the only warranty applicable to the product, and such warranty is given expressly and in lieu of all other warranties, express or implied, or merchantability and fitness for a particular purpose and all such implied warranties which exceed or differ from the warranty set forth herein are hereby disclaimed by EWS.

EXCLUSION OF DAMAGES

EWS' liability for any defective products is limited to the repair or replacement of the product at our option. Except where such limitations and exclusions are specifically prohibited by applicable law EWS shall not be liable for:

- 1) Damage to other property caused by defects in the EWS product, damages based upon inconvenience, loss of use of the product, loss of time, commercial loss or:
- 2) Any damages, whether incidental, [consequential or otherwise] special, indirect or consequential damages, injury to persons or property, or any other loss.

Under no circumstances whatsoever shall EWS be obliged to provide compensation beyond the direct damage incurred by customer up to an amount not exceeding the payment receivable from the insurer of EWS in connection with the damage

APPLICABLE LAW AND DISPUTES

- 1) Dutch law shall govern all offers made by EWS and all agreements concluded between EWS and customer. This warranty explicitly excludes application of the Vienna Sales Convention (CISG).
- 2) All disputes which may arise between the parties shall be dealt with exclusively by the competent court of law in the Netherlands under whose jurisdiction EWS falls. However, EWS reserves the right to submit any disputes to the competent court in the customer's location.